

# GS810

## Reset IC

### Product Description

The GSR810 are microprocessor ( $\mu\text{P}$ ) supervisory circuits used to monitor the power supplies in  $\mu\text{P}$  and digital systems. They provide excellent circuit reliability and low cost by eliminating external components and adjustments when used with +3.3V, +3.0V, or 2.5V powered circuits.

These circuits perform a single function: they assert a reset signal whenever the  $V_{\text{CC}}$  supply voltage declines below a preset threshold, keeping it asserted for at least 200ms after  $V_{\text{CC}}$  has risen above the reset threshold. Reset thresholds suitable for operation with a variety of supply voltages are available.

The GSR810 have push-pull outputs and have an active high RESET output. The reset comparator is designed to ignore fast transients on  $V_{\text{CC}}$ , and the outputs are guaranteed to be in the correct logic state for  $V_{\text{CC}}$  down to 1V.

Low supply current makes the GSR810 ideal for use in portable equipment. The ICs are available in SOT-23 packages.

### Features

- Precision supply-voltage monitor
  - 4.63V (GSR810L)
  - 4.38V (GSR810M)
  - 4.00V (GSR810J)
  - 3.08V (GSR810T)
  - 2.93V (GSR810S)
  - 2.63V (GSR810R)
  - 2.32V (GSR810Z)
- 200ms(min) reset pulse width
- Push-Pull RESET Output Configurations for GSR810
- 9 $\mu\text{A}$  Supply Current
- Guaranteed Reset(Reset) Valid to  $V_{\text{CC}}=+1.0\text{V}$
- Power Supply Transient Immunity
- No External Components
- RoHS Compliant, 100%Pb & Halogen Free

### Applications

- Microprocessor reset circuitry
- Computers
- Wireless
- Embedded Control Systems
- Battery-operated systems

### Block Diagram

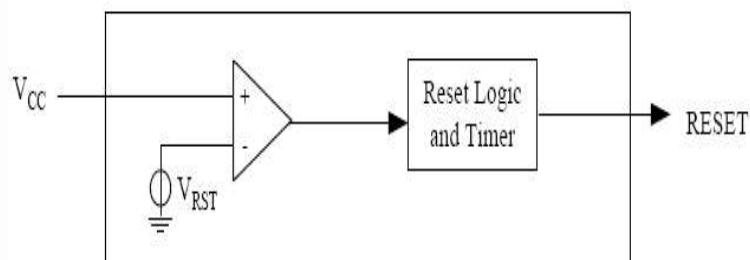

### Packages & Pin Assignments

GSR810xZF (SOT-23)		
	Pin No.	Name
	1	GND
	2	RESET
	3	$V_{\text{CC}}$

## Pin Description

Name	Type	Description
V <sub>CC</sub>	-	Supply Voltage. Reset is asserted when V <sub>CC</sub> drops below the Reset Threshold Voltage (V <sub>RST</sub> ). Reset remains asserted until V <sub>CC</sub> rises above V <sub>RST</sub> and keep asserted for the duration of the Reset Timeout Period (t <sub>RS</sub> ) once V <sub>CC</sub> rises above V <sub>RST</sub> .
GND	-	Ground Pin.
RESET	O	Active-High Reset Output (Push-Pull). It goes high when V <sub>CC</sub> is below the reset threshold. It remains low for about 240ms after V <sub>CC</sub> rises above the reset threshold (V <sub>RST</sub> ).

## Ordering Information

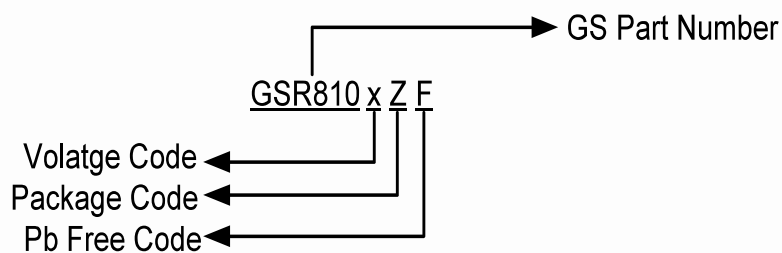

Voltage Code : As following Table :

x	L	M	J	T	S	R	Z
Reset Threshold	4.63V	4.38V	4.00V	3.08V	2.93V	2.63V	2.32V

## Marking Information

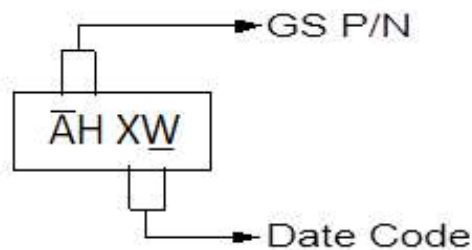

GS P/N	Package	Marking	Reset Threshold
GSR810LZF	SOT-23	AHXW	4.63V
GSR810MZF	SOT-23	AIXW	4.38V
GSR810JZF	SOT-23	ANXW	4.00V
GSR810TZF	SOT-23	AJXW	3.08V
GSR810SZF	SOT-23	AKXW	2.93V
GSR810RZF	SOT-23	ALXW	2.63V
GSR810ZZF	SOT-23	AMXW	2.32V

Note: Year and Work Week must use the actual time of molding process.

## Functional Description

### Reset Output

A microprocessor ( $\mu\text{P}$ ) reset input starts the  $\mu\text{P}$  in a known state. Whenever the  $\mu\text{P}$  is in an unknown state, it should be held in reset. The supervisory circuits assert reset during power-up and prevent code execution errors during power-down or brownout conditions.

On power-up, once  $V_{\text{CC}}$  reaches about 1.0V, RESET is a guaranteed logic high of 0.8V or more. As  $V_{\text{CC}}$  rises, RESET stays high. When  $V_{\text{CC}}$  rises above the reset threshold, an internal timer releases RESET after about 200ms. RESET pulses high whenever  $V_{\text{CC}}$  drops below the reset threshold, i.e. brownout condition. If brownout occurs in the middle of a previously initiated reset pulse, the pulse continues for at least another 200ms. On power-down, once  $V_{\text{CC}}$  falls below the reset threshold, RESET stays high and is guaranteed to be 0.8V or high until  $V_{\text{CC}}$  drops below 1.0V. Reset timing diagram shows the timing relationship.

### Typical Application Circuit

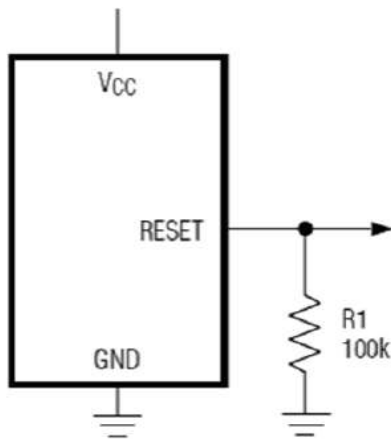

### Absolute Maximum Ratings

Symbol	Parameter	Value	Unit
$V_{\text{CC}}$	Supply Voltage to Ground Potential	-0.3 to +6.0	V
-	All Other Pins Voltage	-0.3 to $V_{\text{CC}}+0.3$	V
$I_{\text{OUT}}$	Output Current	20	mA
$P_{\text{D}}$	Power Dissipation	320	mW
$T_{\text{A}}$	Operating Ambient Temperature Range	-40 to +85	$^{\circ}\text{C}$
$T_{\text{STG}}$	Storage Temperature Range	-55 to +150	$^{\circ}\text{C}$

Note: Stresses greater than those listed under maximum ratings may cause permanent damage to the device. This is a stress rating only and functional operation of the device at these or any other conditions above those indicated in the operational sections of this specification is not implied. Exposure to absolute maximum rating conditions for extended periods may affect reliability.

### Recommended Operation Conditions

Symbol	Parameter	Min	Typ	Max	Unit
$V_{\text{CC}}$	Supply Voltage for GSR810(L/M)	4.5	5.0	5.5	V
	Supply Voltage for GSR810(T/S)	3.0	3.3	5.5	
	Supply Voltage for GSR810(R)	2.8	3.0	5.5	
	Supply Voltage for GSR810(Z)	2.5	-	5.5	
$T_{\text{A}}$	Operating Ambient Temperature Range	-40	-	85	$^{\circ}\text{C}$

## Electrical Characteristics

( $V_{CC}=V_{RN}+5\%$  to 5.5V,  $T_A=-40$  to 85°C, unless otherwise noted.) (Note 1)

Symbol	Parameter	Conditions	Min	Typ	Max	Unit
$V_{CC}$	Operating Voltage Range	-	1.0	-	5.5	V
$I_{CC}$	Supply Current	$V_{CC}<5.5V$ , GSR810(L/M)	-	10	30	$\mu A$
		$V_{CC}<3.6V$ , GSR810(R/S/T/Z)	-	9	30	$\mu A$
$V_{RST}$	Threshold Voltage (Falling Edge) Note 2	GSR810L~Z $T_A=25^\circ C$	$V_{RN}-1.5\%$	$V_{RN}$	$V_{RN}+1.5\%$	V
		GSR810L~Z $T_A=-40$ to 85°C	$V_{RN}-2.5\%$	$V_{RN}$	$V_{RN}+2.5\%$	V
$V_{OH}$	Output High Voltage	$V_{CC} \geq 4.5V$ , $I_{SOURCE}=800\mu A$	$V_{CC}-1.5$	-	-	V
		$V_{CC} \geq 2.7V$ , $I_{SOURCE}=500\mu A$	$0.8 \times V_{CC}$	-	-	V
		$V_{CC} \geq 1.8V$ , $I_{SOURCE}=150\mu A$	$0.8 \times V_{CC}$	-	-	V
		$V_{CC} \geq 1.0V$ , $I_{SOURCE}=4\mu A$	$0.8 \times V_{CC}$	-	-	V
$V_{OL}$	Output Low Voltage	$V_{CC} \geq 4.5V$ , $I_{SINK}=3.2mA$	-	-	0.4	V
		$V_{CC} \geq 2.7V$ , $I_{SINK}=1.2mA$	-	-	0.3	V
		$V_{CC} \geq 1.0V$ , $I_{SINK}=100\mu A$	-	-	0.3	V

Note: 1. Parameters of room temperature guaranteed by production test and parameters of full-temperature guaranteed by design.

2.  $V_{RST}$  is Reset threshold voltage when  $V_{CC}$  falls from high to low level.  $V_{RN}$  is nominal reset threshold voltage.

## AC Electrical Characteristics

Symbol	Parameter	Conditions	Min	Typ	Max	Unit
$t_{RS}$	Reset Time	GSR810L~Z $T_A=-40$ to 85°C	140	240	400	ms

## Reset Timing Diagram

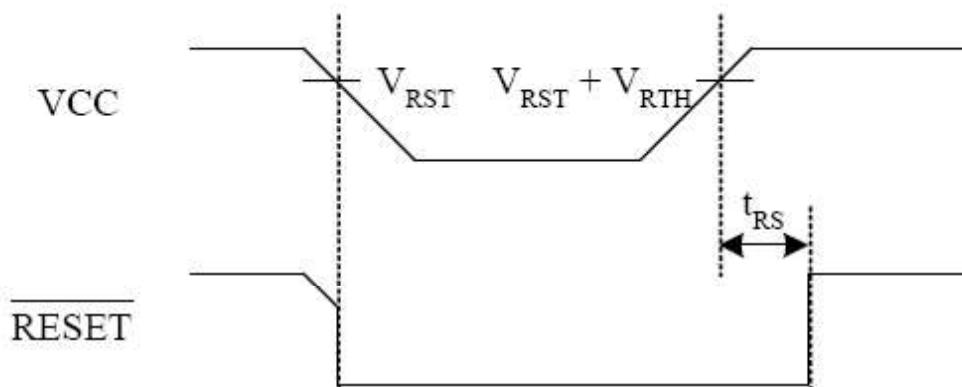

Package Dimension

SOT-23

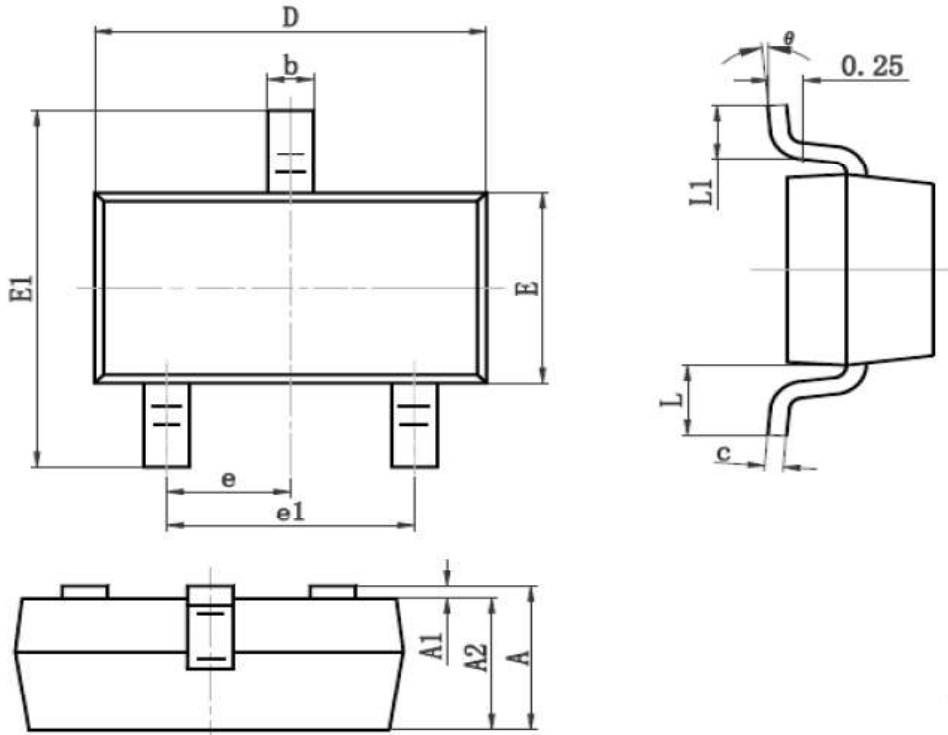





Dimensions



SYMBOL	Millimeters		Inches	
	MIN	MAX	MIN	MAX
A	0.900	1.150	0.035	0.045
A1	0.000	0.100	0.000	0.004
A2	0.900	1.050	0.035	0.041
b	0.300	0.500	0.012	0.020
c	0.080	0.150	0.003	0.006
D	2.800	3.000	0.110	0.118
E	1.200	1.400	0.047	0.055
E1	2.250	2.550	0.089	0.100
e	0.950 (TYP)		0.037 (TYP)	
e1	1.800	2.000	0.071	0.079
L	0.550 (REF)		0.022 (REF)	
L1	0.300	0.500	0.012	0.020
θ	0°	8°	0°	8°

## NOTICE

Information furnished is believed to be accurate and reliable. However Globaltech Semiconductor assumes no responsibility for the consequences of use of such information nor for any infringement of patents or other rights of third parties, which may result from its use. No license is granted by implication or otherwise under any patent or patent rights of Globaltech Semiconductor. Specifications mentioned in this publication are subject to change without notice. This publication supersedes and replaces all information without express written approval of Globaltech Semiconductor.

## CONTACT US

GS Headquarter	
	4F.,No.43-1,Lane11,Sec.6,Minquan E.Rd Neihu District Taipei City 114, Taiwan (R.O.C)
	886-2-2657-9980
	886-2-2657-3630
	sales_twn@gs-power.com

RD Division	
	824 Bolton Drive Milpitas. CA. 95035
	1-408-457-0587