

# GSMDD0906

## 100V N-Channel MOSFETs

### Product Description

These N-Channel enhancement mode power field effect transistors are planar stripe, DMOS technology. This advanced technology has been especially tailored to minimize on-state resistance, provide superior switching performance, and withstand high energy pulse in the avalanche and commutation mode.

These devices are well suited for high efficiency switch mode power supply.

### Features

- 100V, 15A,  $R_{DS(ON)}=90m\Omega@V_{GS}=10V$
- Improved dv/dt capability
- Fast switching
- 100% EAS guaranteed
- Green Device Available
- TO-252-2L package design

### Applications

- Networking
- Load Switch
- LED applications

### Packages & Pin Assignments

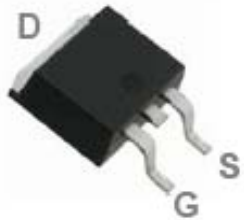
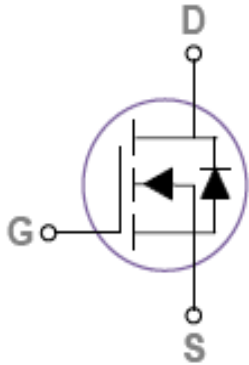
GSMDD0906DF (TO-252-2L)	
 <p>Top View</p>	
<b>Description</b>	
Gate	
Source	
Drain	

## Ordering Information

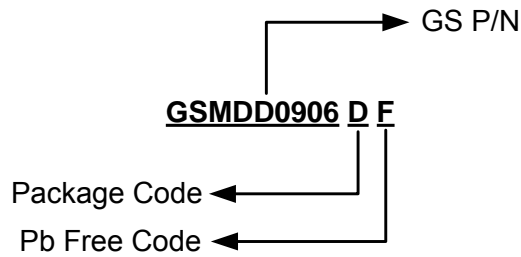

Part Number	Package	Quantity Reel
GSMDD0906DF	TO-252-2L	2500 PCS

## Marking Information

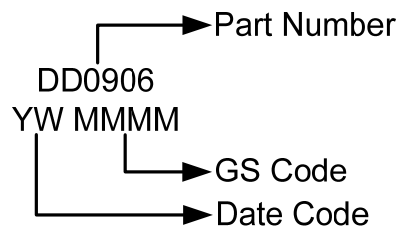

## Absolute Maximum Ratings

T<sub>A</sub>=25°C Unless otherwise noted

Symbol	Parameter	Typical	Unit
V <sub>DS</sub>	Drain-Source Voltage	100	V
V <sub>GS</sub>	Gate-Source Voltage	±20	V
I <sub>D</sub>	Continuous Drain Current	T <sub>A</sub> =25°C	15
		T <sub>A</sub> =100°C	9.5
I <sub>DM</sub>	Pulsed Drain Current	60	A
P <sub>D</sub>	Power Dissipation (T <sub>A</sub> =25°C)	50	W
	Power Dissipation (Derate above 25°C)	0.4	W/°C
T <sub>J</sub>	Operating Junction Temperature Range	-50 to +150	°C
T <sub>STG</sub>	Storage Temperature Range	-50 to +150	°C
R <sub>θJA</sub>	Thermal Resistance-Junction to Ambient	62	°C/W
R <sub>θJC</sub>	Thermal Resistance-Junction to Case	2.5	°C/W

## Electrical Characteristics

T<sub>A</sub>=25°C Unless otherwise noted

Symbol	Parameter	Conditions	Min	Typ	Max	Unit
<b>Static</b>						
V <sub>(BR)DSS</sub>	Drain-Source Breakdown Voltage	V <sub>GS</sub> =0V, I <sub>D</sub> =250uA	100			V
ΔBV <sub>DSS</sub> /ΔT <sub>J</sub>	BV <sub>DSS</sub> Temperature Coefficient	Reference to 25°C, I <sub>D</sub> =1mA		0.05		V/°C
V <sub>GS(th)</sub>	Gate Threshold Voltage	V <sub>DS</sub> =V <sub>GS</sub> , I <sub>D</sub> =250uA	1.2	1.6	2.5	V
ΔV <sub>GS(th)</sub>	V <sub>GS(th)</sub> Temperature Coefficient			-5		mV/°C
I <sub>GSS</sub>	Gate Leakage Current	V <sub>DS</sub> =0V, V <sub>GS</sub> =±20V			±100	nA
I <sub>DSS</sub>	Zero Gate Voltage Drain Current	V <sub>DS</sub> =100V, V <sub>GS</sub> =0V			1	uA
		V <sub>DS</sub> =80V, V <sub>GS</sub> =0V, T <sub>J</sub> =125°C			10	
I <sub>S</sub>	Continuous Source Current	V <sub>G</sub> =V <sub>D</sub> =0V, Force Current			15	A
I <sub>SM</sub>	Pulsed Source Current				60	
R <sub>DS(on)</sub>	Drain-Source On-Resistance	V <sub>GS</sub> =10V, I <sub>D</sub> =5A		72	90	mΩ
		V <sub>GS</sub> =4.5V, I <sub>D</sub> =3A		75	100	mΩ
g <sub>FS</sub>	Forward Transconductance	V <sub>DS</sub> =10V, I <sub>D</sub> =3A		8.7		S
V <sub>SD</sub>	Diode Forward Voltage	V <sub>GS</sub> =0V, I <sub>S</sub> =1A			1	V
<b>Dynamic</b>						
Q <sub>g</sub>	Total Gate Charge	V <sub>DS</sub> =48V, V <sub>GS</sub> =10V, I <sub>D</sub> =5A		9.3	13	nC
Q <sub>gs</sub>	Gate-Source Charge			2.1	4.2	
Q <sub>gd</sub>	Gate-Drain Charge			1.8	4	
C <sub>iss</sub>	Input Capacitance	V <sub>DS</sub> =50V, V <sub>GS</sub> =0V, f=1MHz		1480	2150	pF
C <sub>oss</sub>	Output Capacitance			480	700	
C <sub>rss</sub>	Reverse Transfer Capacitance			35	55	
t <sub>d(on)</sub>	Turn-On Time	V <sub>DD</sub> =30V, I <sub>D</sub> =1A, V <sub>GS</sub> =10V, R <sub>G</sub> =3.3Ω		2.9	6	ns
t <sub>r</sub>				9.5	18	
t <sub>d(off)</sub>	Turn-Off Time			18.4	35	
t <sub>f</sub>				5.3	10	
R <sub>g</sub>	Gate Resistance		V <sub>DS</sub> =0V, V <sub>GS</sub> =0V, f=1MHz		1.3	

## Typical Performance Characteristics

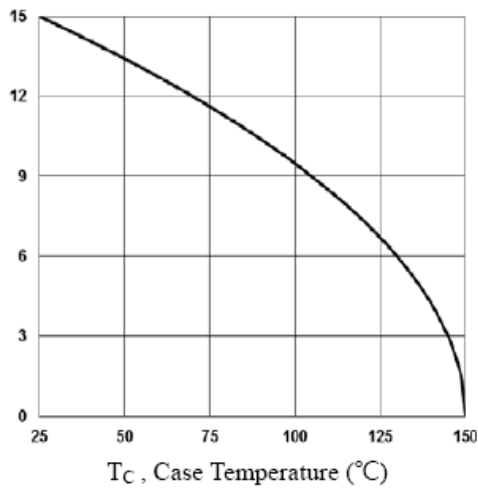

**Fig.1 Continuous Drain Current vs.  $T_C$**

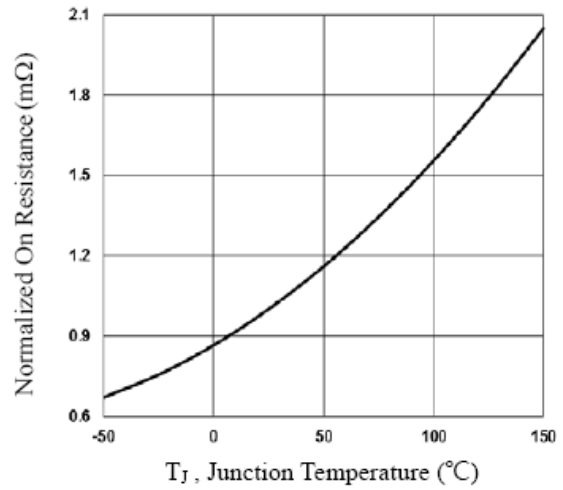

**Fig.2 Normalized  $R_{DS(on)}$  vs.  $T_J$**

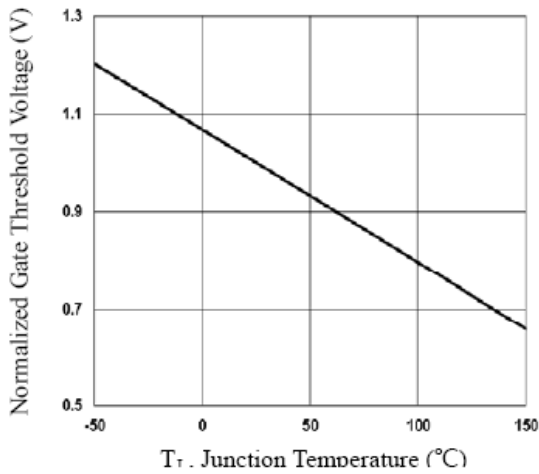

**Fig.3 Normalized  $V_{th}$  vs.  $T_J$**

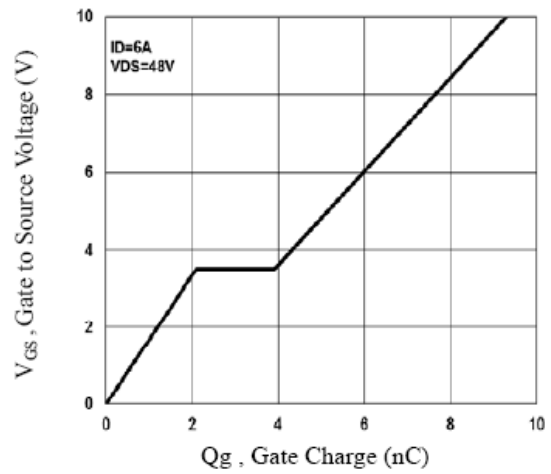

**Fig.4 Gate Charge Characteristics**

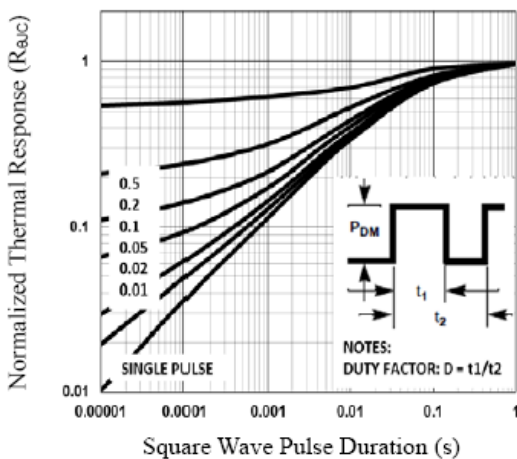

**Fig.5 Normalized Transient Impedance**

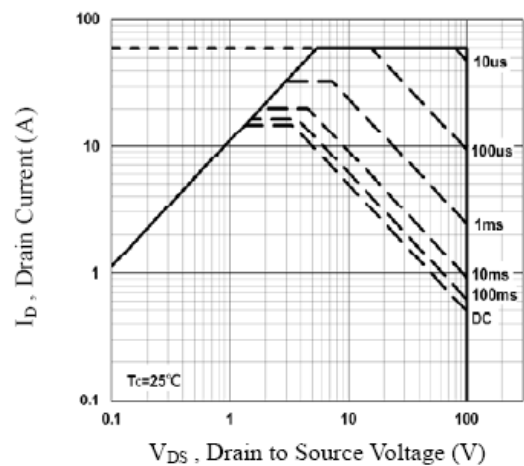

**Fig.6 Maximum Safe Operation Area**

## Typical Performance Characteristics (Continue)

Gate Charge Test Circuit & Waveform

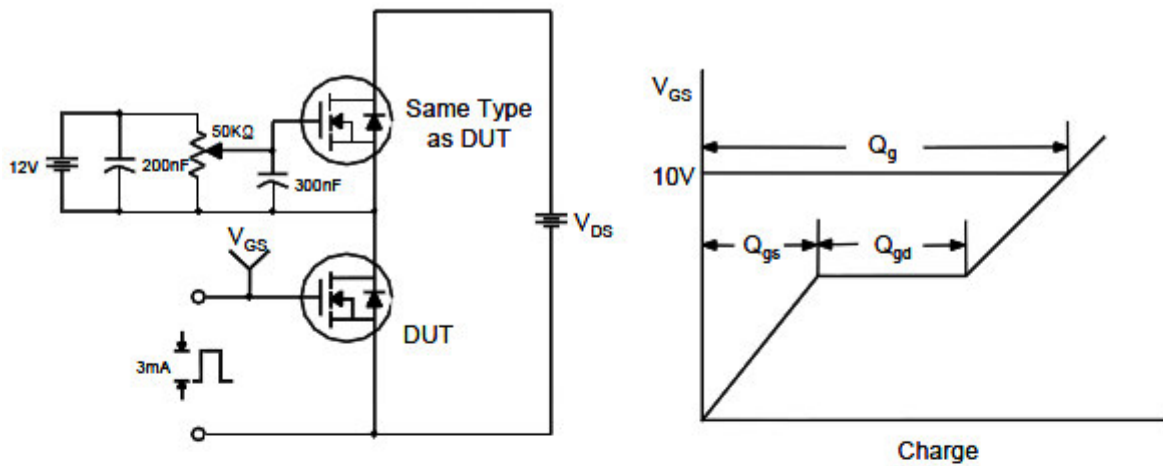

Resistive Switching Test Circuit & Waveforms



Unclamped Inductive Switching Test Circuit & Waveforms



## Package Dimension

### TO-252-2L

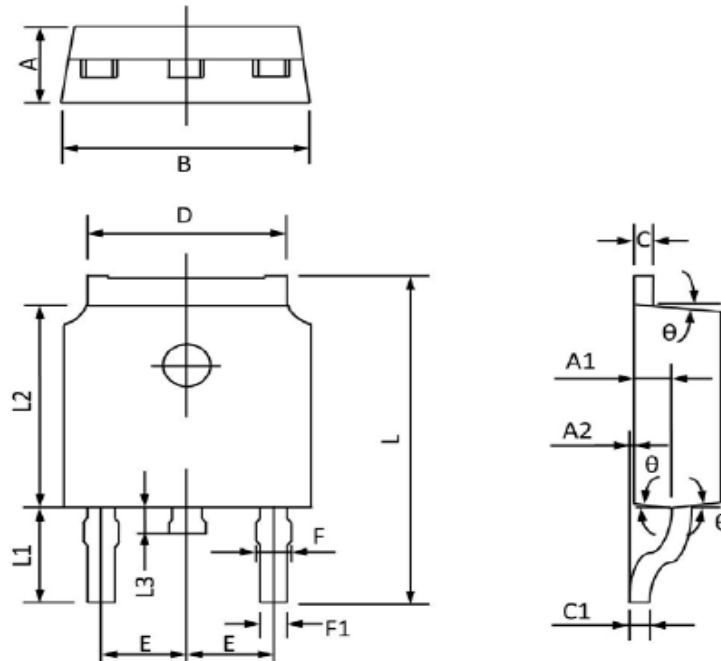







Dimensions				
Symbol	Millimeters		Inches	
	Min	Max	Min	Max
A	2.20	2.40	0.087	0.094
A1	0.91	1.11	0.036	0.044
A2	0.00	0.15	0.000	0.006
B	6.50	6.70	0.256	0.264
C	0.46	0.58	0.018	0.030
C1	0.46	0.58	0.018	0.030
D	5.10	5.46	0.201	0.215
E	2.186	2.386	0.086	0.094
F	0.74	0.94	0.029	0.037
F1	0.66	0.86	0.026	0.034
L	9.80	10.40	0.386	0.409
L1	2.9 (REF)		0.114 (REF)	
L2	6.00	6.20	0.236	0.244
L3	0.60	1.00	0.024	0.039
$\theta$	3°	9°	3°	9°



## NOTICE

Information furnished is believed to be accurate and reliable. However Globaltech Semiconductor assumes no responsibility for the consequences of use of such information nor for any infringement of patents or other rights of third parties, which may result from its use. No license is granted by implication or otherwise under any patent or patent rights of Globaltech Semiconductor. Specifications mentioned in this publication are subject to change without notice. This publication supersedes and replaces all information without express written approval of Globaltech Semiconductor.

## CONTACT US

GS Headquarter	
	4F.,No.43-1,Lane11,Sec.6,Minquan E.Rd Neihu District Taipei City 114, Taiwan (R.O.C)
	886-2-2657-9980
	886-2-2657-3630
	sales_twn@gs-power.com

Shenzhen Branch(China)	
	1113 B Building, Happiness Washington, Baoan Nan Road, Luohu District, Shenzhen City, China
	0755-22208941
	sales_cn@gs-power.com

RD Division	
	824 Bolton Drive Milpitas. CA. 95035
	1-408-457-0587