

GSMDC6904X

60V N-Channel MOSFETs

Product Description

These N-Channel enhancement mode power field effect transistors are using trench DMOS technology. This advanced technology has been especially tailored to minimize on-state resistance, provide superior switching performance, and withstand high energy pulse in the avalanche and commutation mode.

These devices are well suited for high efficiency fast switching applications.

Features

- 60V, 50A, $R_{DS(ON)}=12m\Omega@V_{GS}=10V$
- Improved dv/dt capability
- Fast switching
- 100% EAS guaranteed
- Green Device Available
- DFN5X6-8L package design

Applications

- Motor Drive
- Power Tools
- LED Lighting

Packages & Pin Assignments

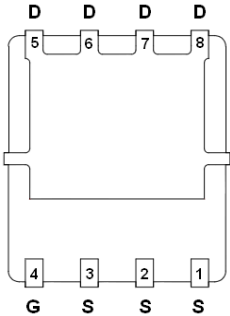
GSMDC6904XFF (DFN5X6-8L)	
 <p style="text-align: center;">Bottom View</p>	
Pin	Description
1	Source
2	Source
3	Source
4	Gate
5	Drain
6	Drain
7	Drain
8	Drain

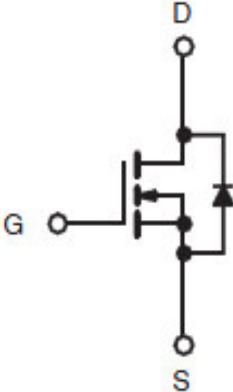

Ordering Information

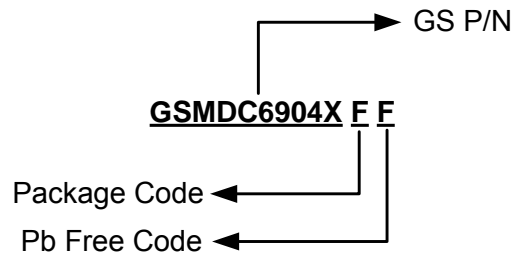

Part Number	Package
GSMDC6904XFF	DFN5X6-8L

Marking Information

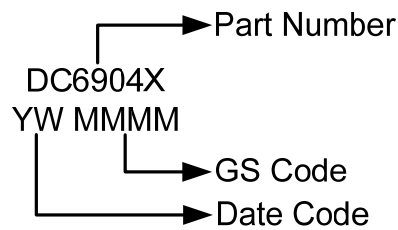

Absolute Maximum Ratings

$T_A=25^{\circ}\text{C}$ Unless otherwise noted

Symbol	Parameter	Typical	Unit
V_{DS}	Drain-Source Voltage	60	V
V_{GS}	Gate-Source Voltage	± 20	V
I_D	Continuous Drain Current	$T_A=25^{\circ}\text{C}$	50
		$T_A=100^{\circ}\text{C}$	31
I_{DM}	Pulsed Drain Current	200	A
EAS	Single Pulse Avalanche Energy	61	mJ
IAS	Single Pulse Avalanche Current	35	A
P_D	Power Dissipation ($T_A=25^{\circ}\text{C}$)	96	W
	Power Dissipation (Derate above 25°C)	0.77	W/ $^{\circ}\text{C}$
T_J	Operating Junction Temperature Range	-55 to +150	$^{\circ}\text{C}$
T_{STG}	Storage Temperature Range	-55 to +150	$^{\circ}\text{C}$
$R_{\theta JA}$	Thermal Resistance-Junction to Ambient	62	$^{\circ}\text{C}/\text{W}$
$R_{\theta JC}$	Thermal Resistance-Junction to Case	1.3	$^{\circ}\text{C}/\text{W}$

Electrical Characteristics

T_A=25°C Unless otherwise noted

Symbol	Parameter	Conditions	Min	Typ	Max	Unit
Static						
V _{(BR)DSS}	Drain-Source Breakdown Voltage	V _{GS} =0V, I _D =250uA	60			V
ΔBV _{DSS} /ΔT _J	BV _{DSS} Temperature Coefficient	Reference to 25°C, I _D =1mA		0.03		V/°C
V _{GS(th)}	Gate Threshold Voltage	V _{DS} =V _{GS} , I _D =250uA	1.2	1.6	2.5	V
ΔV _{GS(th)}	V _{GS(th)} Temperature Coefficient			-4		mV/°C
I _{GSS}	Gate Leakage Current	V _{DS} =0V, V _{GS} =±20V			±100	nA
I _{DSS}	Zero Gate Voltage Drain Current	V _{DS} =60V, V _{GS} =0V			1	uA
		V _{DS} =48V, V _{GS} =0V, T _J =125°C			10	
I _S	Continuous Source Current	V _G =V _D =0V, Force Current			55	A
I _{SM}	Pulsed Source Current				220	
R _{DS(on)}	Drain-Source On-Resistance	V _{GS} =10V, I _D =10A		10	12	mΩ
		V _{GS} =4.5V, I _D =8A		12	15	
g _{FS}	Forward Transconductance	V _{DS} =10V, I _D =6A		11.7		S
V _{SD}	Diode Forward Voltage	V _{GS} =0V, I _S =1A			1	V
Dynamic						
Q _g	Total Gate Charge	V _{DS} =30V, V _{GS} =10V, I _D =10A		39.2	59	nC
Q _{gs}	Gate-Source Charge			5.9	9	
Q _{gd}	Gate-Drain Charge			8.8	14	
C _{iss}	Input Capacitance	V _{DS} =25V, V _{GS} =0V, f=1MHz		2100	3050	pF
C _{oss}	Output Capacitance			165	240	
C _{rss}	Reverse Transfer Capacitance			80	120	
t _{d(on)}	Turn-On Time	V _{DD} =15V, I _D =1A, V _{GS} =10V, R _G =6Ω		9.6	18	ns
t _r				28.2	54	
t _{d(off)}	Turn-Off Time			45.3	86	
t _f				10.9	21	
R _g	Gate Resistance		V _{DS} =0V, V _{GS} =0V, f=1MHz		1.6	

Typical Performance Characteristics

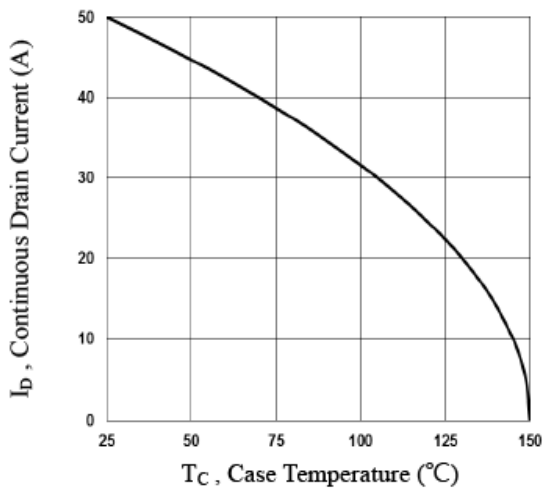

Fig.1 Continuous Drain Current vs. T_c

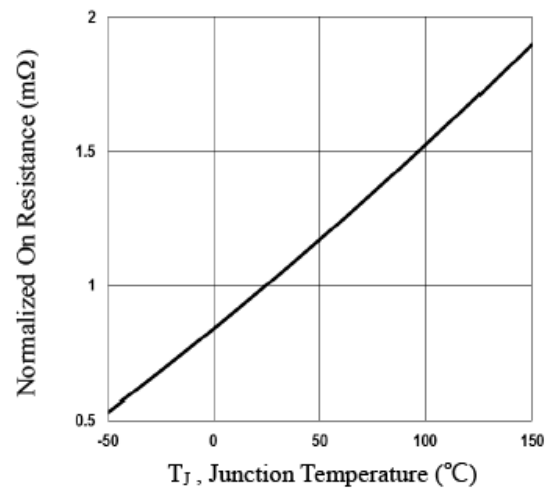

Fig.2 Normalized $R_{DS(on)}$ vs. T_j

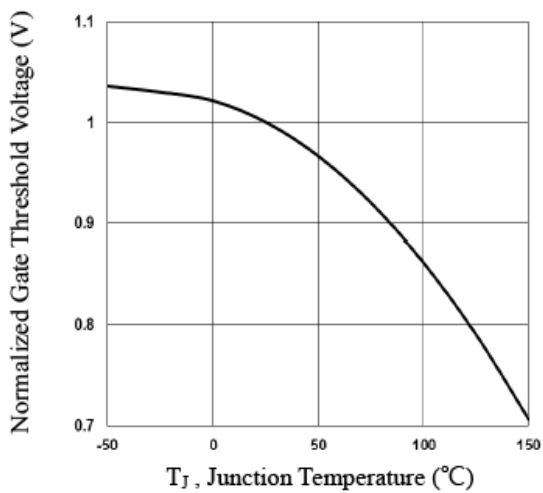

Fig.3 Normalized V_{th} vs. T_j

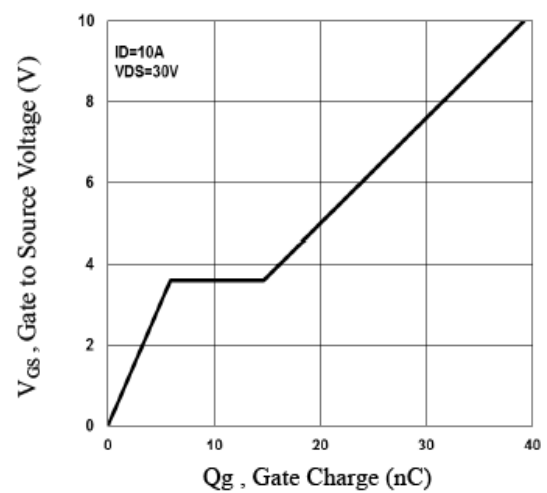

Fig.4 Gate Charge Waveform

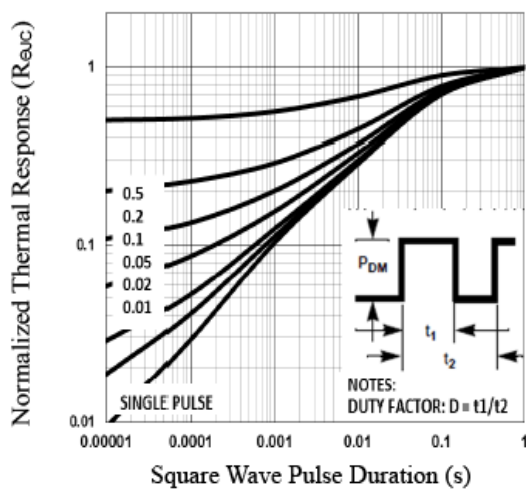

Fig.5 Normalized Transient Response

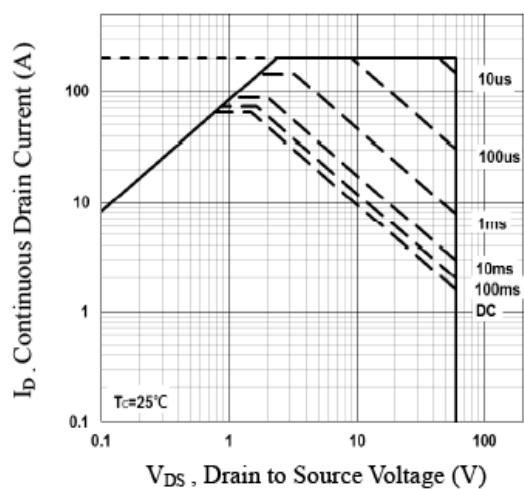
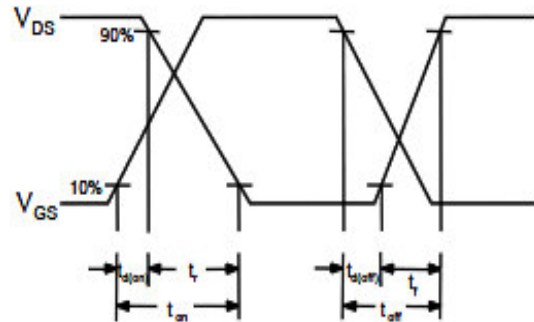
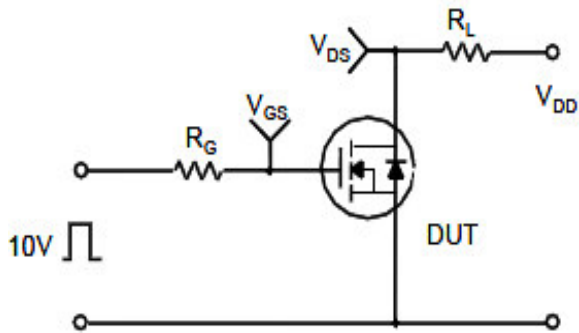

Fig.6 Maximum Safe Operation Area

Typical Performance Characteristics (Continue)

Resistive Switching Test Circuit & Waveforms



Unclamped Inductive Switching Test Circuit & Waveforms

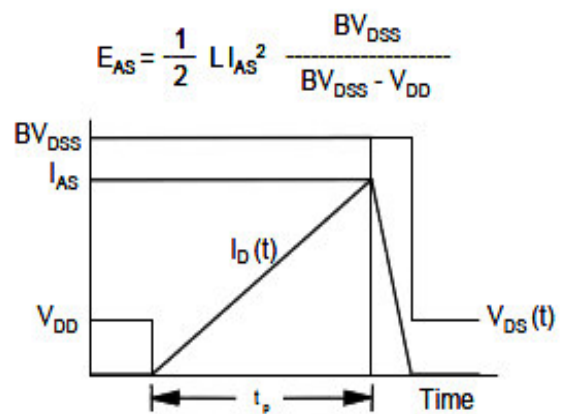
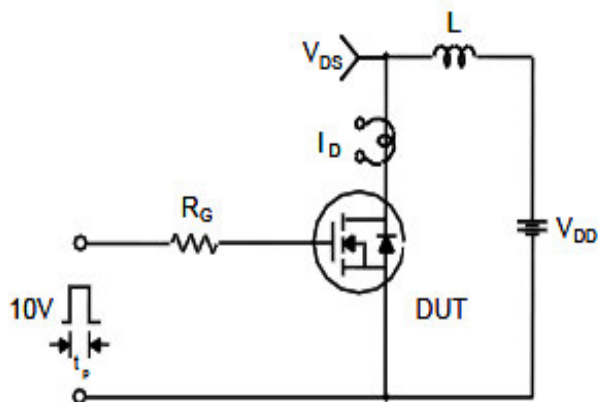

Package Dimension

DFN5X6-8L

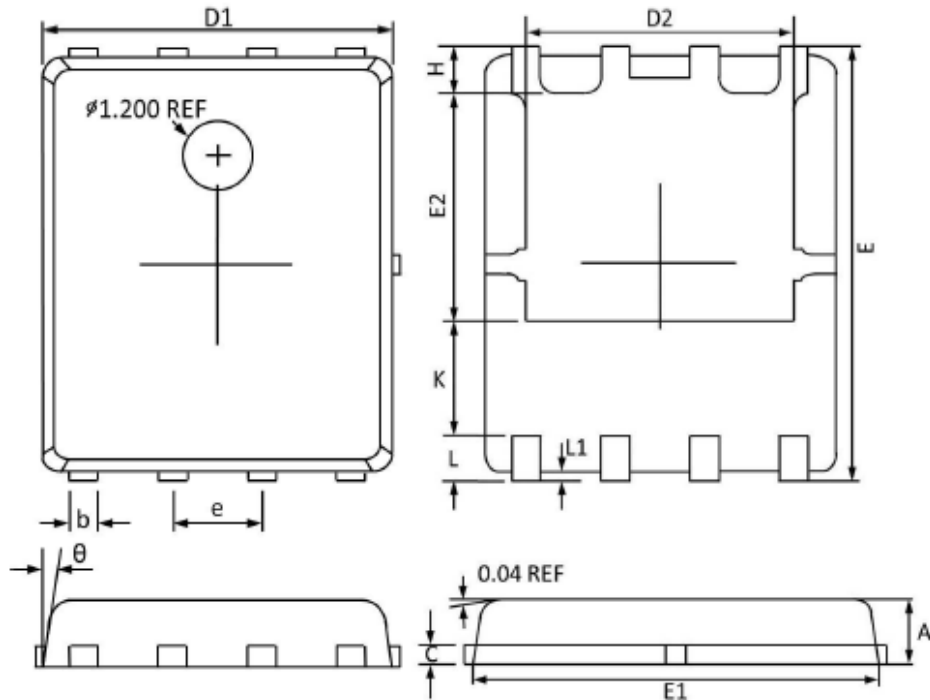





Dimensions



Symbol	Millimeters		Inches	
	Min	Max	Min	Max
A	0.800	1.100	0.031	0.043
b	0.330	0.510	0.013	0.020
C	0.200	0.300	0.008	0.012
D1	4.800	5.100	0.189	0.201
D2	3.610	4.100	0.142	0.161
E	5.900	6.200	0.232	0.244
E1	5.700	5.900	0.224	0.232
E2	3.350	3.780	0.132	0.149
e	1.27 (BSC)		0.05 (BSC)	
H	0.410	0.700	0.016	0.028
K	1.100	1.500	0.043	0.059
L	0.510	0.710	0.020	0.028
L1	0.060	0.200	0.002	0.008
θ	0°	12°	0°	12°



NOTICE

Information furnished is believed to be accurate and reliable. However Globaltech Semiconductor assumes no responsibility for the consequences of use of such information nor for any infringement of patents or other rights of third parties, which may result from its use. No license is granted by implication or otherwise under any patent or patent rights of Globaltech Semiconductor. Specifications mentioned in this publication are subject to change without notice. This publication supersedes and replaces all information without express written approval of Globaltech Semiconductor.

CONTACT US

GS Headquarter	
	4F.,No.43-1,Lane11,Sec.6,Minquan E.Rd NeiHu District Taipei City 114, Taiwan (R.O.C)
	886-2-2657-9980
	886-2-2657-3630
	sales_twn@gs-power.com

Shenzhen Branch(China)	
	1113 B Building, Happiness Washington, Baoan Nan Road, Luohu District, Shenzhen City, China
	0755-22208941
	sales_cn@gs-power.com

RD Division	
	824 Bolton Drive Milpitas. CA. 95035
	1-408-457-0587