

GSMDB2116S

20V N+P Dual Channel MOSFETs

Product Description

These N+P dual Channel enhancement mode power field effect transistors are using trench DMOS technology. This advanced technology has been especially tailored to minimize on-state resistance, provide superior switching performance, and withstand high energy pulse in the avalanche and commutation mode.

These devices are well suited for high efficiency fast switching applications.

Features

- N-Channel
20V, 5A, $R_{DS(ON)}=40m\Omega@V_{GS}=4.5V$
- P-Channel
-20V, -4.7A, $R_{DS(ON)}=95m\Omega@V_{GS}=-4.5V$
- Fast switching
- Suit for -1.8V/1.8V Gate Drive Applications
- Green Device Available
- DFN2X2-6L package design

Applications

- Notebook
- Load Switch
- Networking
- Hand-held Instruments

Packages & Pin Assignments

GSMDB2116SFF (DFN2X2-6L)	
<p style="text-align: center;">Top Views</p>	
Pin	Description
1	Source 1
2	Gate 1
3	Drain 2
4	Source 2
5	Gate 2
6	Drain 1

Ordering Information

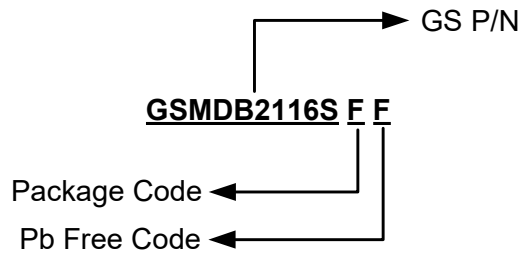

Marking Information

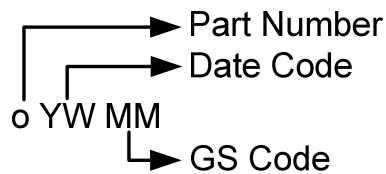

Part Number	Package	Part Marking	Quantity
GSMDB2116SFF	DFN2X2-6L	oYWMM	4000pcs

Absolute Maximum Ratings

T_c=25°C Unless otherwise noted

Symbol	Parameter	Typical		Unit	
		N-Channel	P-Channel		
V _{DS}	Drain-Source Voltage	20	-20	V	
V _{GS}	Gate-Source Voltage	±10	±10	V	
I _D	Continuous Drain Current (T _J =150°C)	T _c =25°C	5	-4.7	A
		T _c =100°C	4.1	-3.9	
I _{DM}	Pulsed Drain Current (Note 1)	15.2	-10	A	
P _D	Power Dissipation	T _c =25°C	1.56	W	
		Derate above 25°C	0.01	W/°C	
T _J	Operating Junction Temperature Range	-55 to +150		°C	
T _{STG}	Storage Temperature Range	-55 to +150		°C	
R _{θJA}	Thermal Resistance-Junction to Ambient	80		°C/W	
R _{θJC}	Thermal Resistance-Junction to Case	15		°C/W	

Note 1: Repetitive Rating: Pulsed width limited by maximum junction temperature.

Electrical Characteristics (N-Channel)

T_J=25°C Unless otherwise noted

Symbol	Parameter	Conditions	Min	Typ	Max	Unit
Static						
V _{(BR)DSS}	Drain-Source Breakdown Voltage	V _{GS} =0V, I _D =250uA	20			V
ΔBV _{DSS} /ΔT _J	BV _{DSS} Temperature Coefficient	Reference to 25°C, I _D =1mA		0.02		V/°C
V _{GS(th)}	Gate Threshold Voltage		0.3	0.6	1.0	V
ΔV _{GS(th)}	V _{GS(th)} Temperature Coefficient	V _{DS} =V _{GS} , I _D =250uA		-2		mV/°C
I _{GSS}	Gate Leakage Current	V _{DS} =0V, V _{GS} =±10V			±100	nA
I _{DSS}	Zero Gate Voltage Drain Current	V _{DS} =20V, V _{GS} =0V			1	uA
		V _{DS} =16V, V _{GS} =0V, T _J =125°C			10	
I _S	Continuous Source Current	V _G =V _D =0V, Force Current			5	A
I _{SM}	Pulsed Source Current				10	
R _{DS(on)}	Drain-Source On-Resistance	V _{GS} =4.5V, I _D =3A		30	40	mΩ
		V _{GS} =2.5V, I _D =2A		42	55	
		V _{GS} =1.8V, I _D =1.5A		55	70	
g _{FS}	Forward Transconductance	V _{DS} =10V, I _D =2A		4.4		S
V _{SD}	Diode Forward Voltage	V _{GS} =0V, I _S =1A			1	V
Dynamic						
Q _g	Total Gate Charge	V _{DS} =10V, V _{GS} =4.5V, I _D =3A		5.8	10	nC
Q _{gs}	Gate-Source Charge			0.6	1.5	
Q _{gd}	Gate-Drain Charge			1.5	3	
C _{iss}	Input Capacitance	V _{DS} =15V, V _{GS} =0V, f=1MHz		315	600	pF
C _{oss}	Output Capacitance			50	80	
C _{rss}	Reverse Transfer Capacitance			40	60	
t _{d(on)}	Turn-On Time (Note 2,3)	V _{DD} =10V, I _D =1A, V _{GS} =4.5V, R _G =25Ω		2.9	6	ns
t _r				8.4	16	
t _{d(off)}	Turn-Off Time (Note 2,3)			19.2	38	
t _f				5.6	12	

Note 2: The data tested by pulsed, pulse width ≤ 300us, duty cycle ≤ 2%.

Note 3: Essentially independent of operating temperature.

Electrical Characteristics (P-Channel)

T_J=25°C Unless otherwise noted

Symbol	Parameter	Conditions	Min	Typ	Max	Unit
Static						
V _{(BR)DSS}	Drain-Source Breakdown Voltage	V _{GS} =0V, I _D =-250uA	-20			V
ΔBV _{DSS} /ΔT _J	BV _{DSS} Temperature Coefficient	Reference to 25°C, I _D =-1mA		-0.01		V/°C
V _{GS(th)}	Gate Threshold Voltage		-0.3	-0.6	-1.0	V
ΔV _{GS(th)}	V _{GS(th)} Temperature Coefficient	V _{DS} =V _{GS} , I _D =-250uA		3		mV/°C
I _{GSS}	Gate Leakage Current	V _{DS} =0V, V _{GS} =±10V			±100	nA
I _{DSS}	Zero Gate Voltage Drain Current	V _{DS} =-20V, V _{GS} =0V			-1	uA
		V _{DS} =-16V, V _{GS} =0V, T _J =125°C			-10	
I _S	Continuous Source Current	V _G =V _D =0V, Force Current			-4.7	A
I _{SM}	Pulsed Source Current				-9.4	
R _{DS(on)}	Drain-Source On-Resistance	V _{GS} = -4.5V, I _D = -3A		80	95	mΩ
		V _{GS} = -2.5V, I _D = -2A		109	125	
		V _{GS} = -1.8V, I _D = -1A		148	161	
g _{FS}	Forward Transconductance	V _{DS} =-10V, I _D =-1A		2.2		S
V _{SD}	Diode Forward Voltage	V _{GS} =0V, I _S =-1A			-1	V
Dynamic						
Q _g	Total Gate Charge	V _{DS} =-10V, V _{GS} =-4.5V, I _D =-2A		4.8	10	nC
Q _{gs}	Gate-Source Charge			0.5	1	
Q _{gd}	Gate-Drain Charge			1.9	4	
C _{iss}	Input Capacitance	V _{DS} =-15V, V _{GS} =0V, f=1MHz		350	510	pF
C _{oss}	Output Capacitance			65	95	
C _{rss}	Reverse Transfer Capacitance			50	75	
t _{d(on)}	Turn-On Time (Note 2,3)	V _{DD} =-10V, I _D =-1A, V _{GS} =-4.5V, R _G =25Ω		3.5	7	ns
t _r				12.6	24	
t _{d(off)}	Turn-Off Time (Note 2,3)			32.6	62	
t _f				8.4	16	

Note 2: The data tested by pulsed, pulse width ≤ 300us, duty cycle ≤ 2%.

Note 3: Essentially independent of operating temperature.

Typical Performance Characteristics (N-Channel)

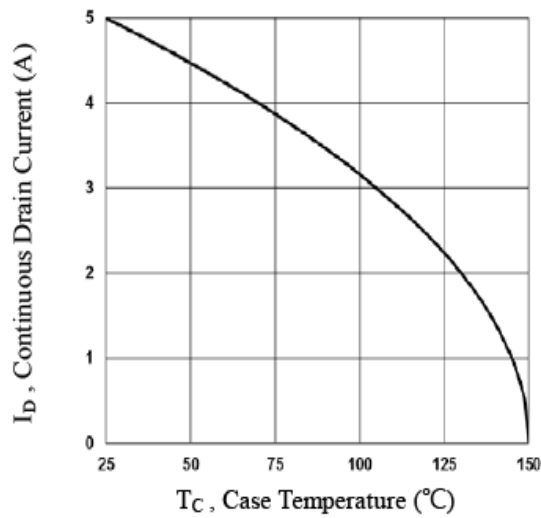

Fig.1 Continuous Drain Current vs. T_c

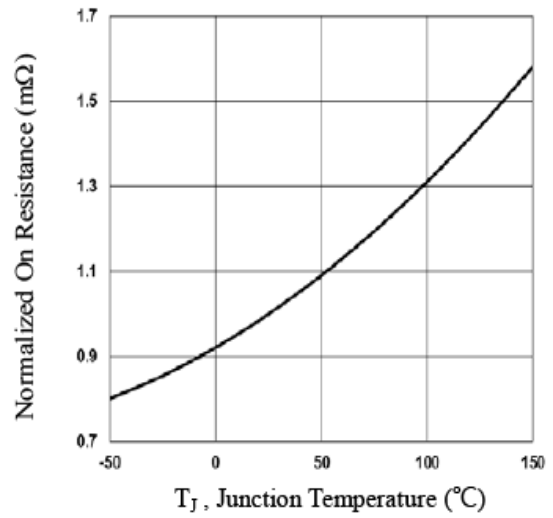

Fig.2 Normalized $R_{DS(on)}$ vs. T_j

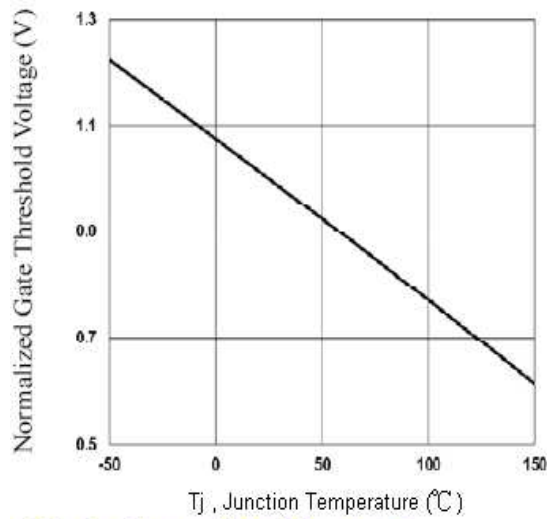

Fig.3 Normalized V_{th} vs. T_j

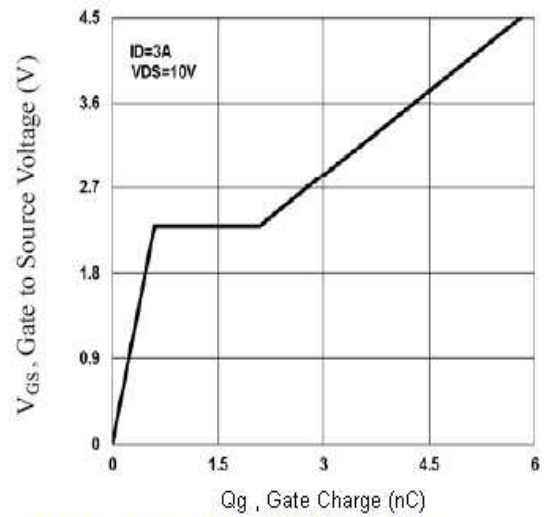

Fig.4 Gate Charge Waveform

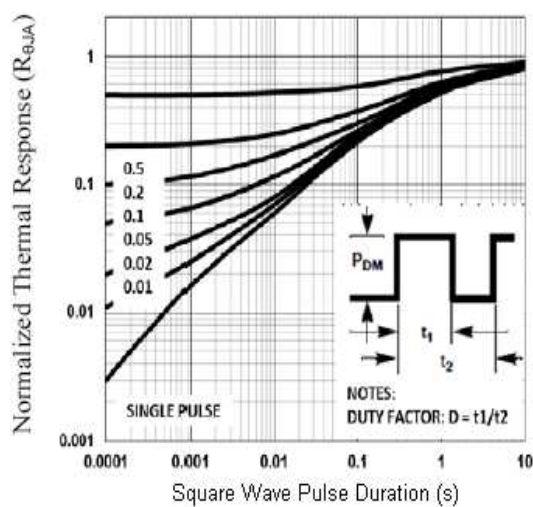

Fig.5 Normalized Transient Impedance

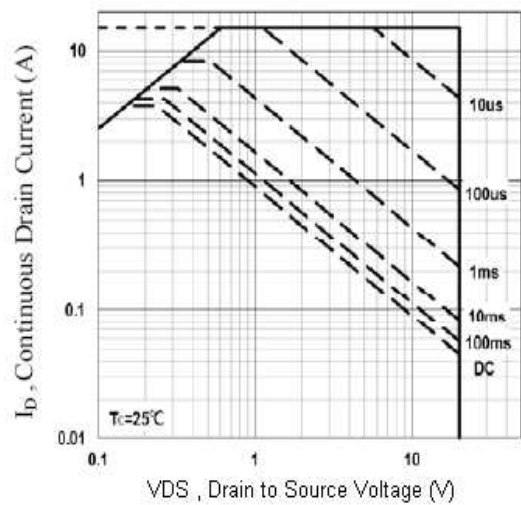
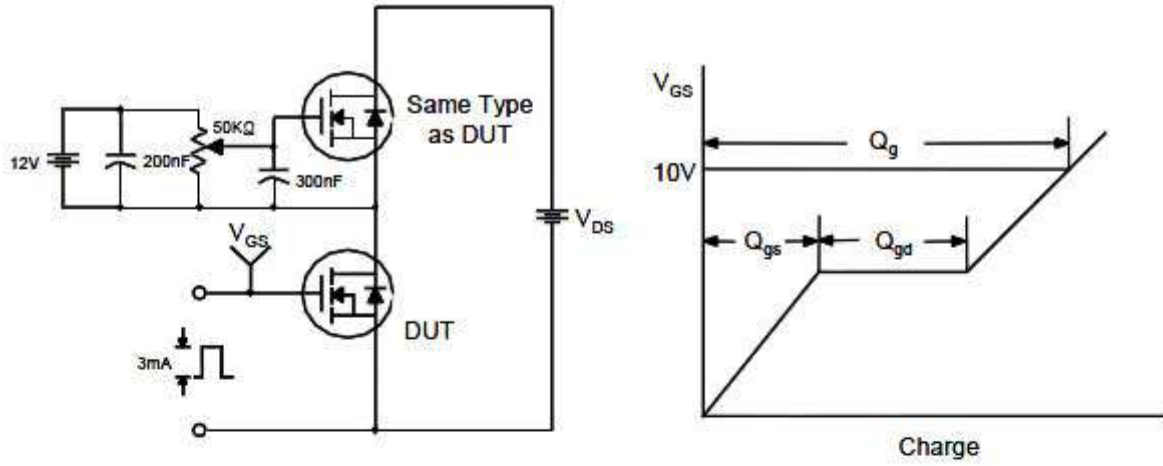

Fig.6 Maximum Safe Operation Area

Typical Performance Characteristics (N-Channel)

Gate Charge Test Circuit & Waveform



Resistive Switching Test Circuit & Waveforms

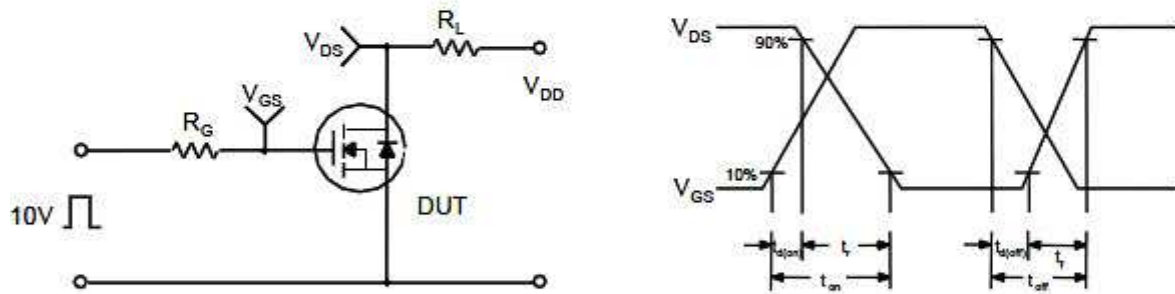

Unclamped Inductive Switching Test Circuit & Waveforms

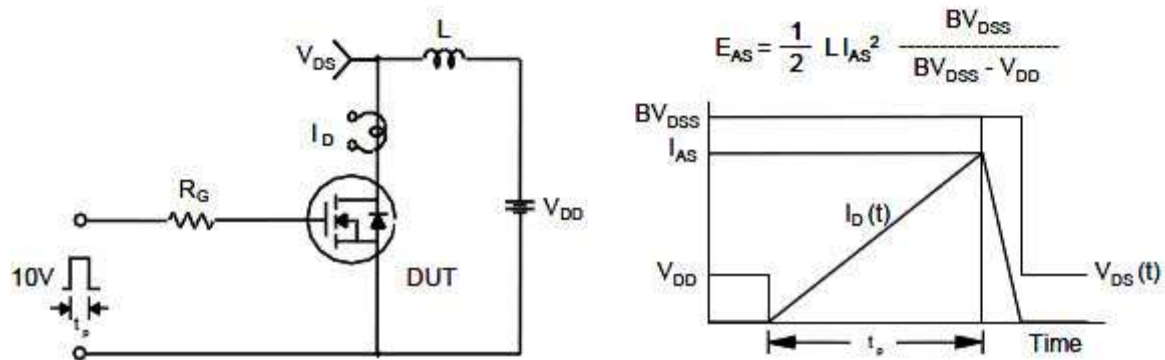

Typical Performance Characteristics (P-Channel)

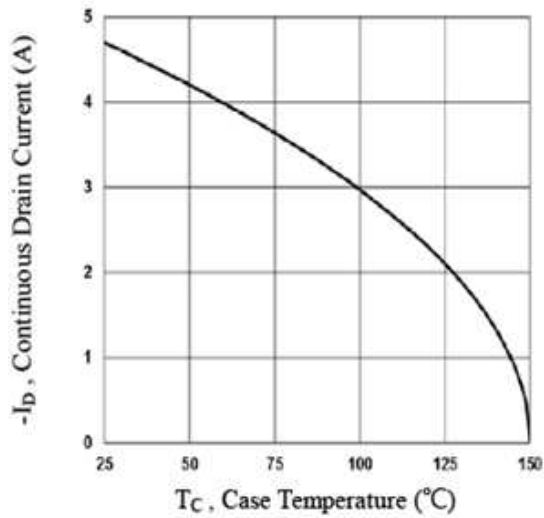

Fig.7 Continuous Drain Current vs. T_c

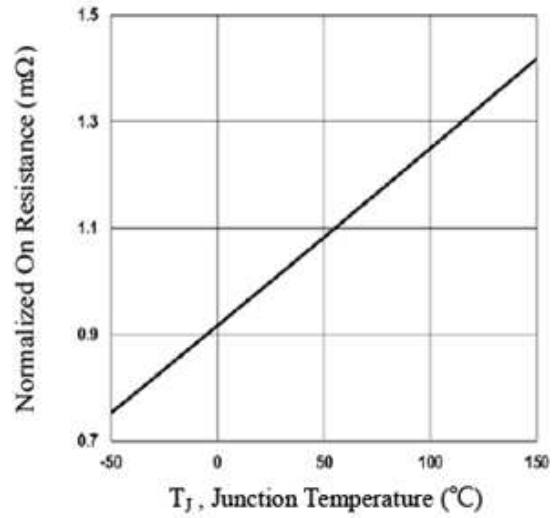

Fig.8 Normalized $R_{DS(on)}$ vs. T_j

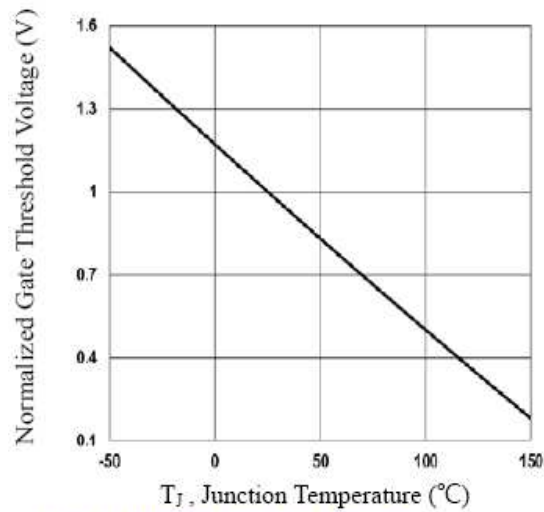

Fig.9 Normalized V_{th} vs. T_j

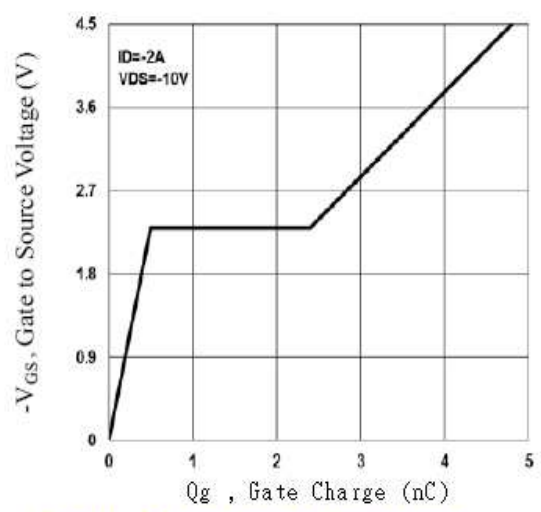

Fig.10 Gate Charge Waveform

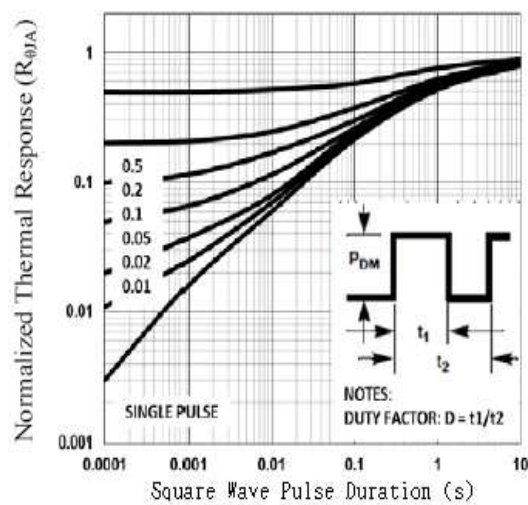

Fig.11 Normalized Transient Impedance

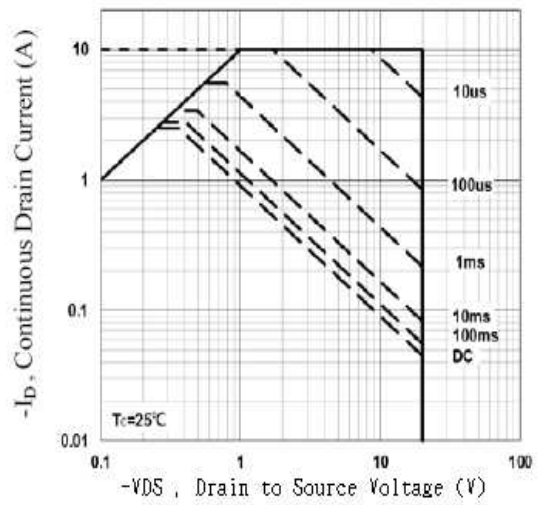
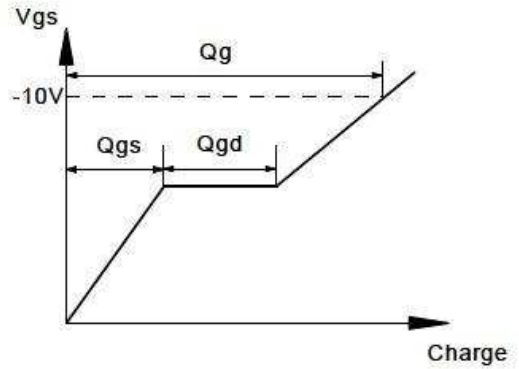
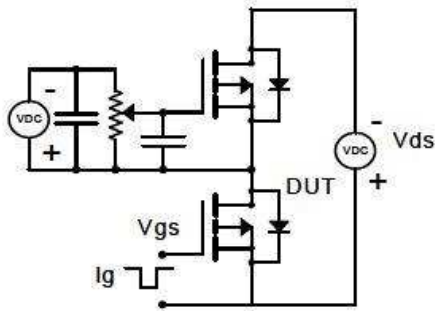

Fig.12 Maximum Safe Operation Area

Typical Performance Characteristics (P-Channel)

Gate Charge Test Circuit & Waveform



Resistive Switching Test Circuit & Waveforms

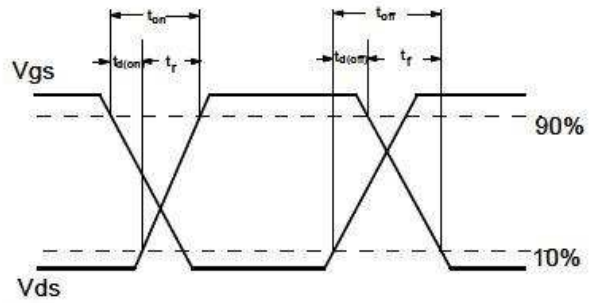
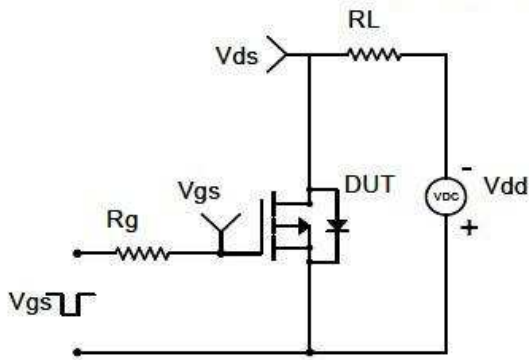

Diode Recovery Test Circuit & Waveforms

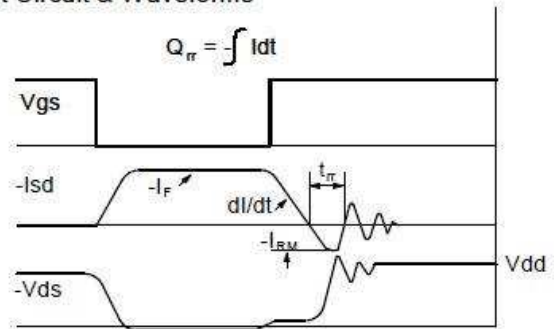
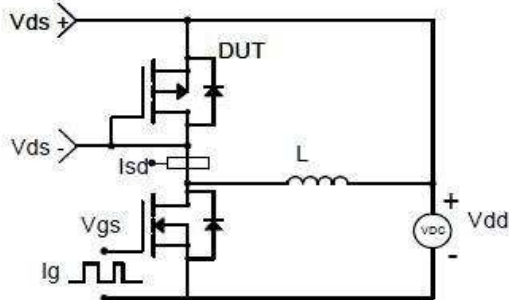

Package Dimension

DFN2X2-6L

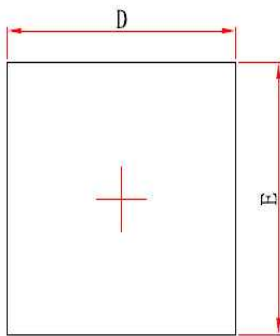

Top View

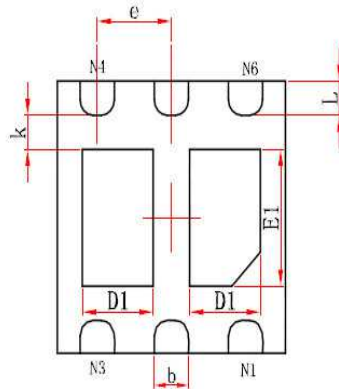

Bottom View

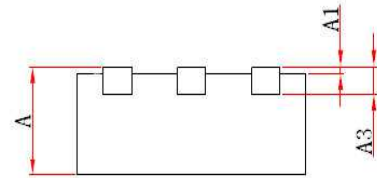

Side View





Dimensions



SYMBOL	Millimeters		Inches	
	MIN	MAX	MIN	MAX
A	0.700/0.800	0.800/0.900	0.028/0.031	0.031/0.035
A1	0.000	0.050	0.000	0.002
A3	0.203 (REF)		0.008 (REF)	
D	1.924	2.076	0.076	0.082
E	1.924	2.076	0.076	0.082
D1	0.520	0.720	0.020	0.028
E1	0.900	1.100	0.035	0.043
k	0.200 (MIN)		0.008 (MIN)	
b	0.250	0.350	0.010	0.014
e	0.650 (TYP)		0.026 (TYP)	
L	0.174	0.326	0.007	0.013

NOTICE

Information furnished is believed to be accurate and reliable. However Globaltech Semiconductor assumes no responsibility for the consequences of use of such information nor for any infringement of patents or other rights of third parties, which may result from its use. No license is granted by implication or otherwise under any patent or patent rights of Globaltech Semiconductor. Specifications mentioned in this publication are subject to change without notice. This publication supersedes and replaces all information without express written approval of Globaltech Semiconductor.

CONTACT US

GS Headquarter	
	4F.,No.43-1,Lane11,Sec.6,Minquan E.Rd Neihu District Taipei City 114, Taiwan (R.O.C)
	886-2-2657-9980
	886-2-2657-3630
	sales_twn@gs-power.com

RD Division	
	824 Bolton Drive Milpitas. CA. 95035
	1-408-457-0587