

GSM8412

100V N-Channel Enhancement Mode MOSFET

Product Description

GSM8412, N-Channel enhancement mode MOSFET, uses Advanced Trench Technology to provide excellent $R_{DS(ON)}$, low gate charge.

These devices are particularly suited for low voltage power management, and low in-line power loss are needed in commercial industrial surface mount applications.

Features

- 100V/3.6A, $R_{DS(ON)}=300m\Omega@V_{GS}=10V$
- 100V/3.0A, $R_{DS(ON)}=310m\Omega@V_{GS}=4.5V$
- Super high density cell design for extremely low $R_{DS(ON)}$
- SOT-223 package design

Applications

- Motor and Load Control
- Power Management in White LED System
- Push Pull Converter
- LCD TV Inverter & AC/DC Inverter Systems.

Packages & Pin Assignments

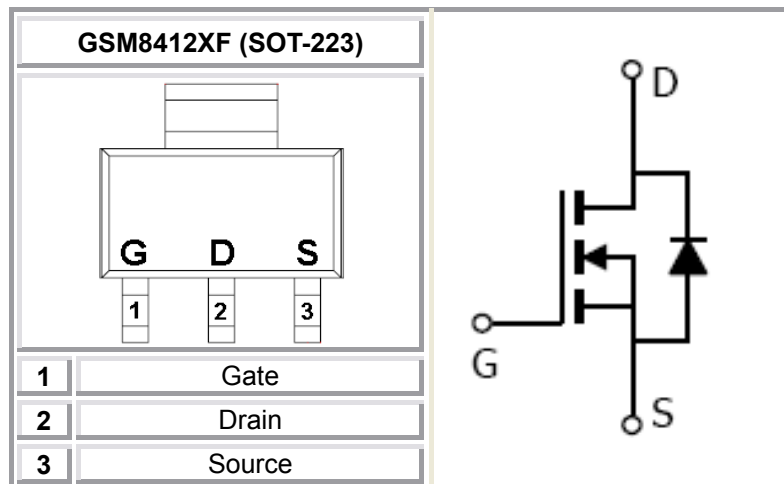

Ordering Information

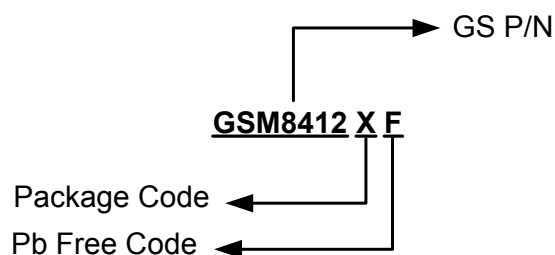

Marking Information

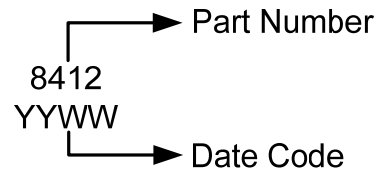

Part Number	Package	Part Marking	Quantity Reel
GSM8412XF	SOT-223	8412YYWW	2500PCS

Absolute Maximum Ratings

(T_A=25°C Unless otherwise noted)

Symbol	Parameter	Typical	Unit	
V _{DSS}	Drain-Source Voltage	100	V	
V _{GSS}	Gate –Source Voltage	±20	V	
I _D	Continuous Drain Current(T _J =150°C)	T _A =25°C	3.6	A
		T _A =70°C	2.6	
I _{DM}	Pulsed Drain Current	8	A	
I _S	Continuous Source Current(Diode Conduction)	1.6	A	
P _D	Power Dissipation	T _A =25°C	2.8	W
		T _A =70°C	1.2	
T _J	Operating Junction Temperature	150	°C	
T _{STG}	Storage Temperature Range	-55/150	°C	
R _{θJA}	Thermal Resistance-Junction to Ambient	120	°C/W	

Electrical Characteristics

(T_A=25°C Unless otherwise noted)

Symbol	Parameter	Conditions	Min	Typ	Max	Unit
Static						
V _{(BR)DSS}	Drain-Source Breakdown Voltage	V _{GS} =0V, I _D =250μA	100			V
V _{GS(th)}	Gate Threshold Voltage	V _{DS} =V _{GS} , I _D =250μA	1.0		2.0	
I _{GSS}	Gate Leakage Current	V _{DS} =0V, V _{GS} =±20V			±100	nA
I _{DSS}	Zero Gate Voltage Drain Current	V _{DS} = 80V, V _{GS} =0V			1	μA
		V _{DS} = 80V, V _{GS} =0V , T _J =85°C			10	
I _{D(on)}	On-State Drain Current	V _{DS} ≥ 5.0V, V _{GS} =4.5V	5			A
R _{DS(on)}	Drain-Source On-Resistance	V _{GS} =10V, I _D =3.6A		284	300	mΩ
		V _{GS} =4.5V, I _D =3.0A		288	310	
g _{FS}	Forward Transconductance	V _{DS} =20V, I _D =1.5A		2		S
V _{SD}	Diode Forward Voltage	I _S =1.3A, V _{GS} =0V		0.85	1.2	V
Dynamic						
Q _g	Total Gate Charge	V _{DS} =50V, V _{GS} =4.5V, I _D =1.6A		2.8	5.8	nC
Q _{gs}	Gate-Source Charge			0.75		
Q _{gd}	Gate-Drain Charge			1.4		
C _{ISS}	Input Capacitance	V _{DS} =50V, V _{GS} =0V f=1MHz		200		pF
C _{OSS}	Output Capacitance			22		
C _{RSS}	Reverse Transfer Capacitance			13		
t _{d(on)}	Turn-On Time	V _{DD} =50V, R _L =39Ω I _D =1.3A, V _{GEN} =4.5V R _G =1.0Ω		25	50	ns
t _r				20	50	
t _{d(off)}	Turn-Off Time			15	30	
t _f				10	25	

Typical Performance Characteristics

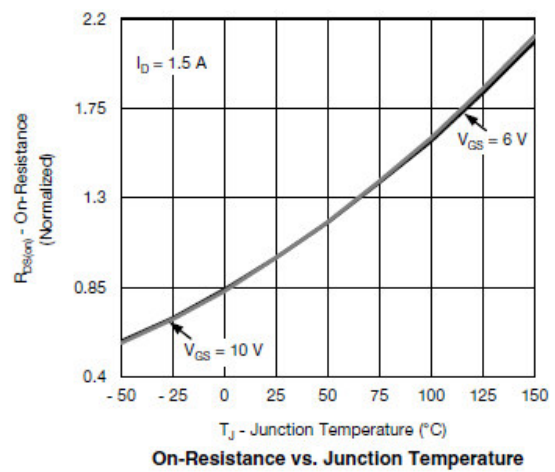
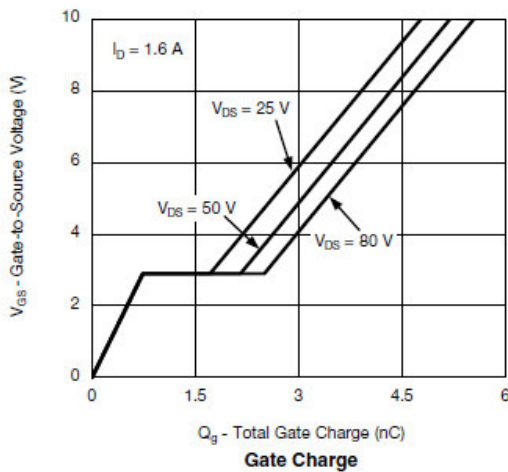
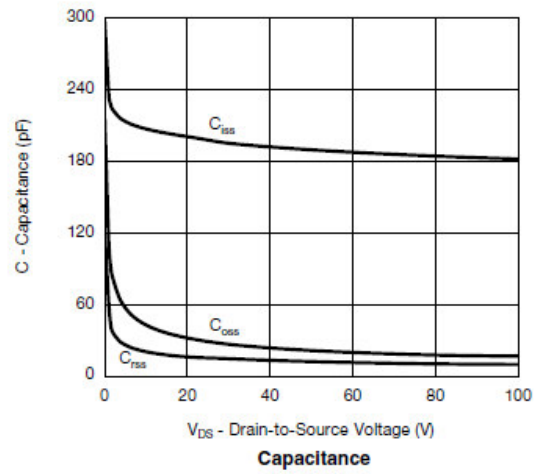
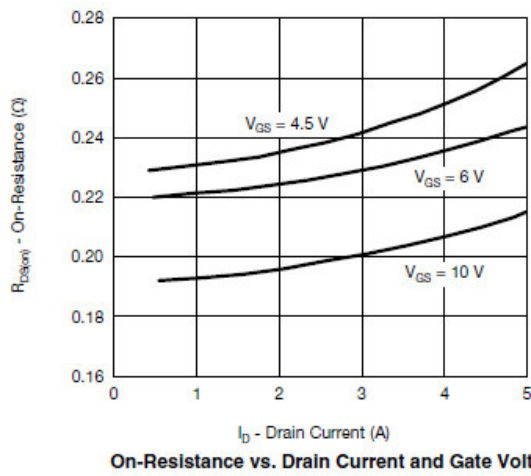
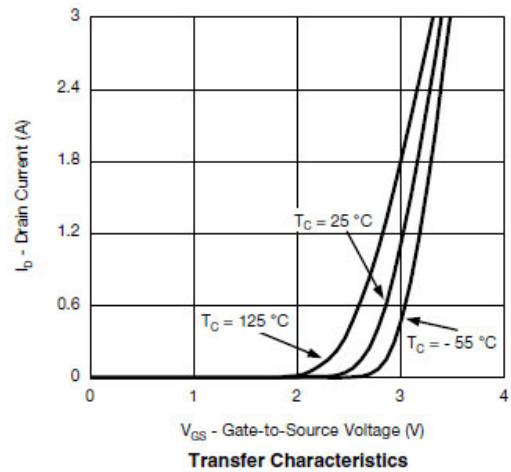
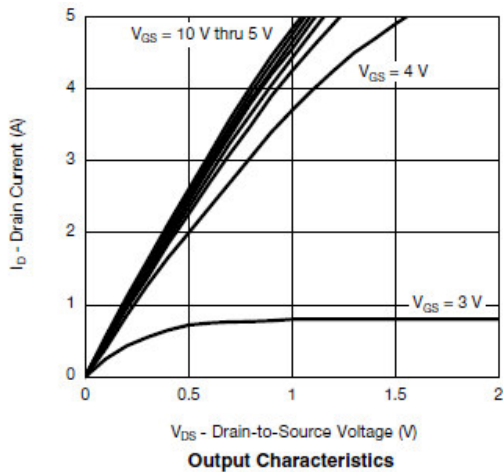

Typical Performance Characteristics(continue)

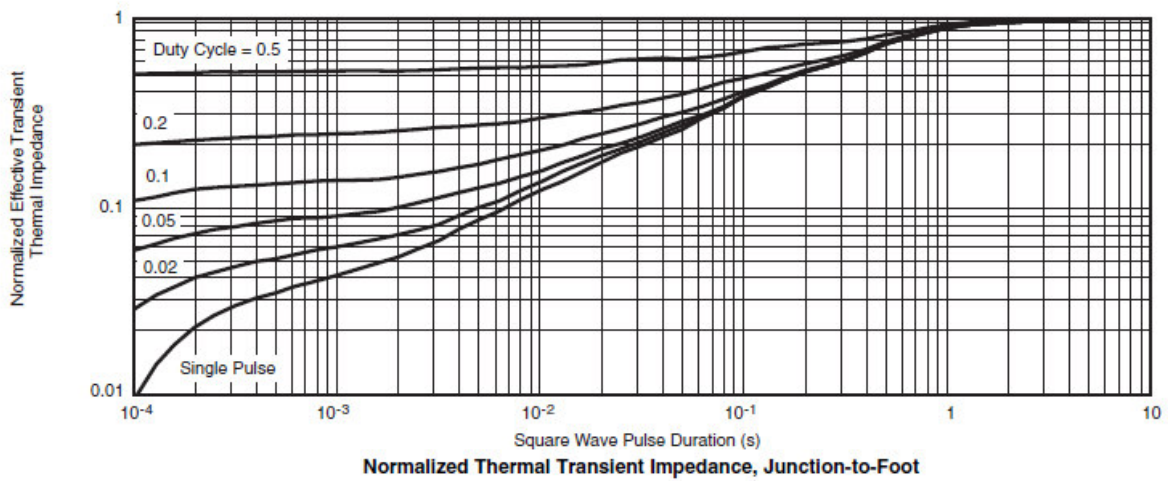
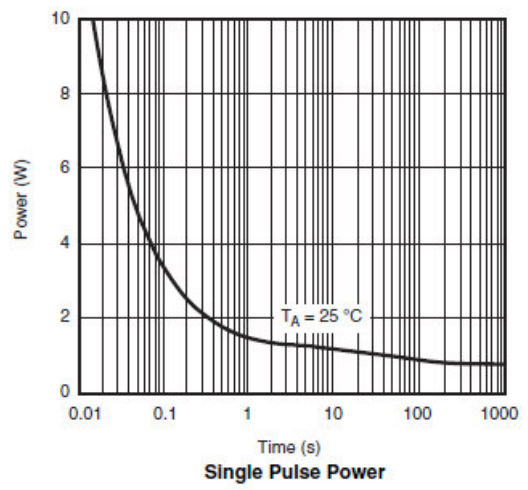
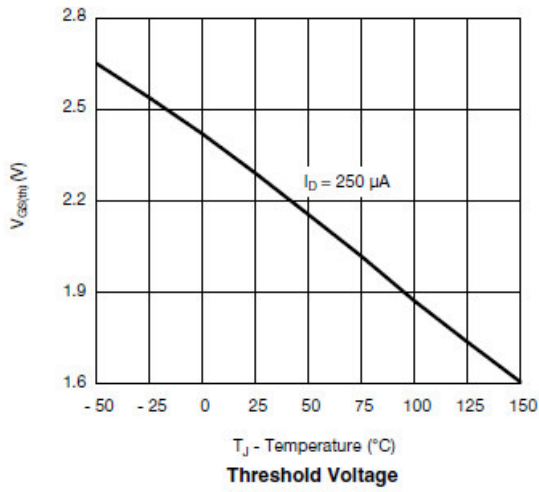
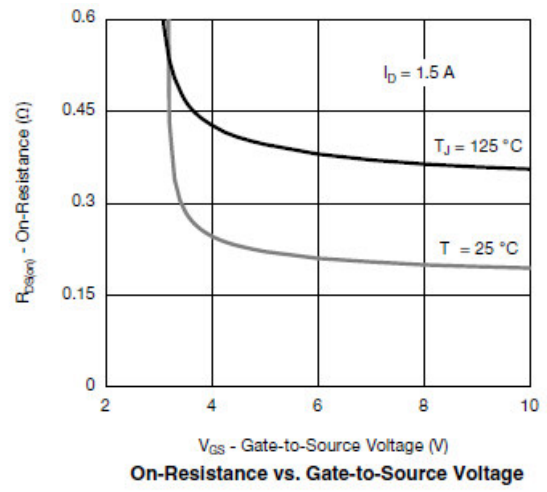
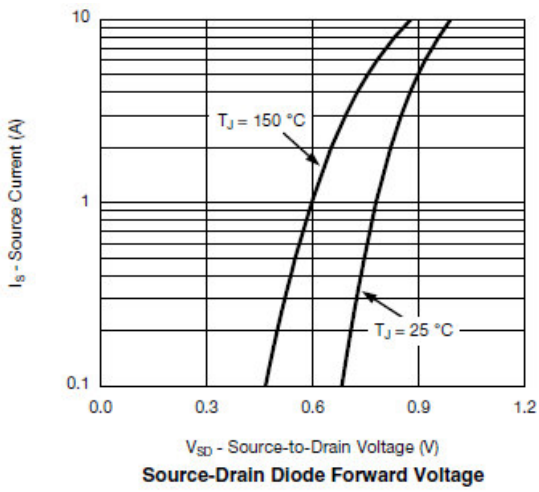

Typical Performance Characteristics(continue)

Gate Charge Test Circuit & Waveform

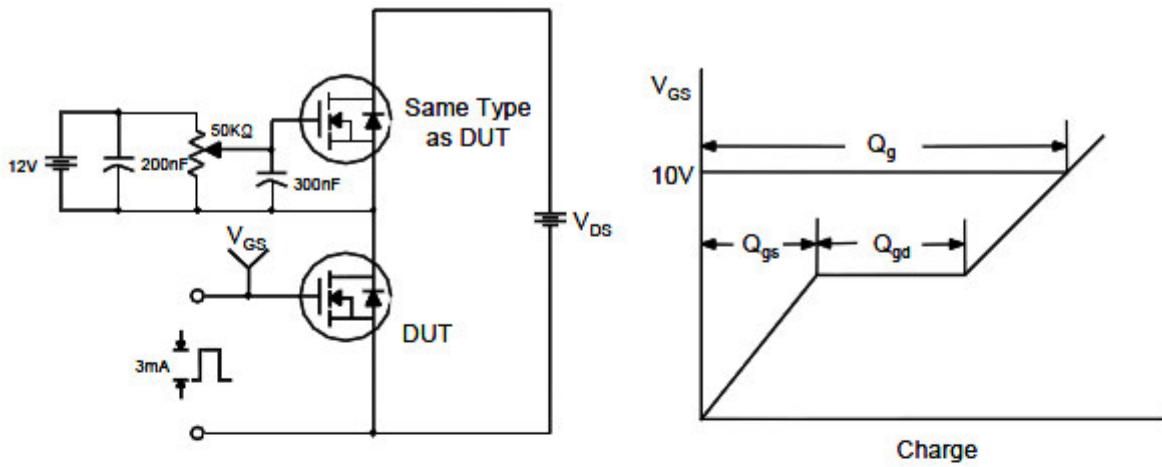

Resistive Switching Test Circuit & Waveforms

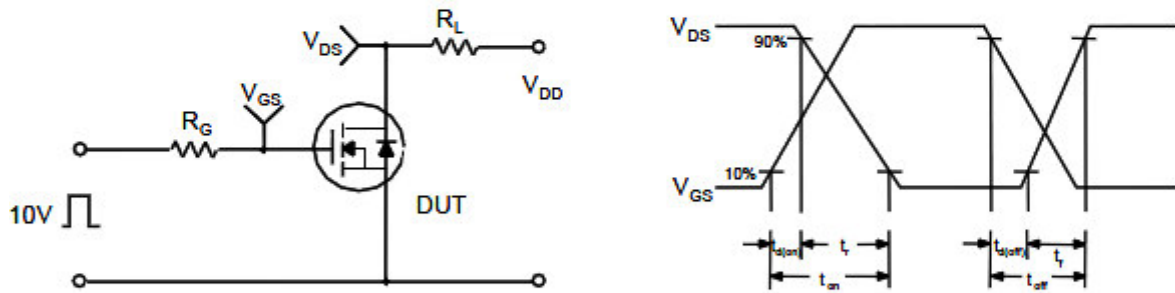

Unclamped Inductive Switching Test Circuit & Waveforms

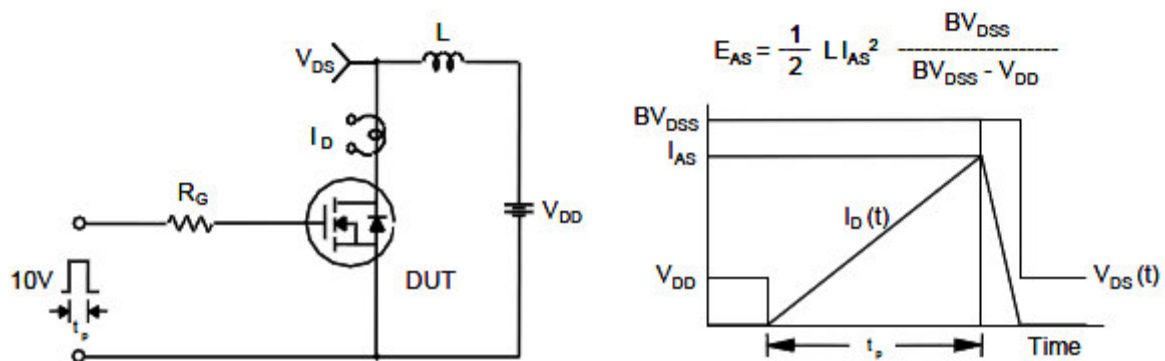

Package Dimension

SOT-223 PLASTIC PACKAGE

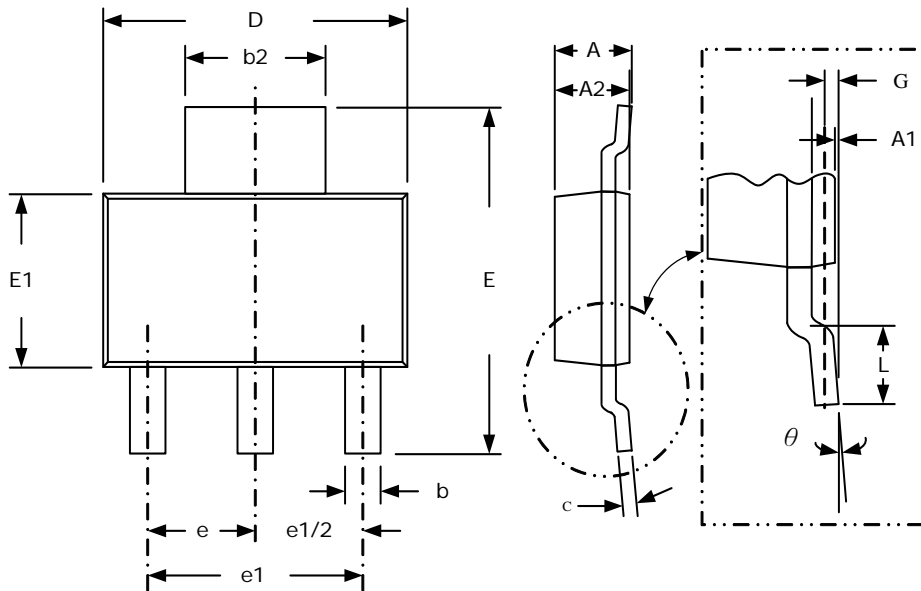









Dimensions				
SYMBOL	Millimeters		Inches	
	MIN	MAX	MIN	MAX
A	-	1.80	-	.071
A1	0.02	0.10	.001	.004
A2	1.55	1.65	.061	.065
b	0.66	0.84	.026	.033
b2	2.90	3.10	.114	.122
c	0.23	0.33	.009	.013
D	6.30	6.70	.248	.264
E	6.70	7.30	.264	.288
E1	3.30	3.70	.130	.146
e	2.30 (TYP)		.091 (TYP)	
e1	4.60 (TYP)		.181 (TYP)	
L	0.90	-	.035	-
G	0.25 (TYP)		.010 (TYP)	
θ	0°	8°	0°	8°



NOTICE

Information furnished is believed to be accurate and reliable. However Globaltech Semiconductor assumes no responsibility for the consequences of use of such information nor for any infringement of patents or other rights of third parties, which may result from its use. No license is granted by implication or otherwise under any patent or patent rights of Globaltech Semiconductor. Specifications mentioned in this publication are subject to change without notice. This publication supersedes and replaces all information without express written approval of Globaltech Semiconductor.

CONTACT US

GS Headquarter	
	4F.,No.43-1,Lane11,Sec.6,Minquan E.Rd Neihu District Taipei City 114, Taiwan (R.O.C)
	886-2-2657-9980
	886-2-2657-3630
	sales_twn@gs-power.com

Wu-Xi Branch	
	No.21 Changjiang Rd., WND, Wuxi, Jiangsu, China (INFO. &. TECH. Science Park Building A 210 Room)
	86-510-85217051
	86-510-85211238
	sales_cn@gs-power.com

RD Division	
	824 Bolton Drive Milpitas. CA. 95035
	1-408-457-0587