

# GSM4909D

## 40V P-Channel MOSFET

### Product Description

These P-Channel enhancement mode power field effect transistors are using trench DMOS technology. This advanced technology has been especially tailored to minimize on-state resistance, provide superior switching performance, and withstand high energy pulse in the avalanche and commutation mode.

These devices are well suited for high efficiency fast switching applications.

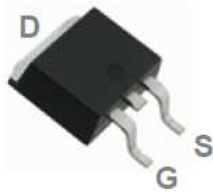
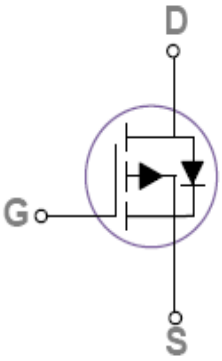
### Features

- -40V, -16A,  $R_{DS(ON)} = 45m\Omega @ V_{GS} = -10V$
- Fast switching
- Green Device Available
- Improved dv/dt capability

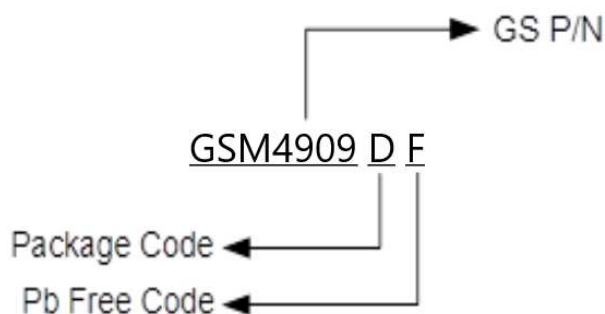
### Applications

- Motor Drive
- Power Tools
- LED Lighting

### Packages & Pin Assignments

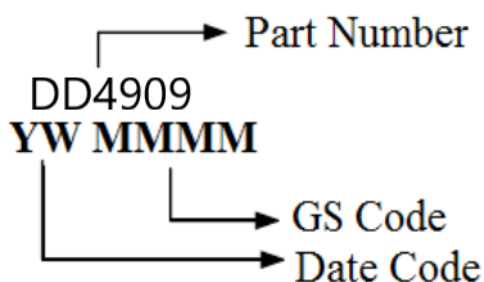
GSM4909DF (TO-252-2L)		
 <p>Top View</p>		
<b>Description</b>		
Gate		
Drain		
Source		

## Ordering Information



Part Number	Package	Quantity
GSM4909DF	TO-252-2L	2500pcs

## Marking Information



## Absolute Maximum Ratings

$T_C=25^\circ\text{C}$  Unless otherwise noted

Symbol	Parameter	Typical	Unit
$V_{DS}$	Drain-Source Voltage	-40	V
$V_{GS}$	Gate-Source Voltage	$\pm 20$	V
$I_D$	Continuous Drain Current	$T_C=25^\circ\text{C}$	-16
		$T_C=100^\circ\text{C}$	-10
$I_{DM}$	Pulsed Drain Current <sup>1</sup>	-64	A
EAS	Single Pulse Avalanche Energy <sup>2</sup>	31	mJ
IAS	Single Pulse Avalanche Current <sup>2</sup>	25	A
$P_D$	Power Dissipation	32.9	W
	Power Dissipation-Derate above $25^\circ\text{C}$	0.26	W/ $^\circ\text{C}$
$T_J$	Operating Junction Temperature Range	-50 to +150	$^\circ\text{C}$
$T_{STG}$	Storage Temperature Range	-50 to +150	$^\circ\text{C}$
$R_{\theta JA}$	Thermal Resistance-Junction to Ambient	62	$^\circ\text{C}/\text{W}$
$R_{\theta JC}$	Thermal Resistance-Junction to Case	3.8	$^\circ\text{C}/\text{W}$

## Electrical Characteristics

T<sub>J</sub>=25°C Unless otherwise noted

Symbol	Parameter	Conditions	Min	Typ	Max	Unit
<b>Static</b>						
V <sub>(BR)DSS</sub>	Drain-Source Breakdown Voltage	V <sub>GS</sub> =0V, I <sub>D</sub> =-250uA	-40			V
$\frac{\Delta V_{(BR)DSS}}{\Delta T_J}$	V <sub>(BR)DSS</sub> Temperature Coefficient	Reference to 25°C, I <sub>D</sub> =-1mA		-0.05		V/°C
V <sub>GS(th)</sub>	Gate Threshold Voltage	V <sub>DS</sub> =V <sub>GS</sub> , I <sub>D</sub> =-250uA	-1.2	-1.6	-2.5	V
$\Delta V_{GS(th)}$	V <sub>GS(th)</sub> Temperature Coefficient			5		mV/°C
I <sub>GSS</sub>	Gate-Source Leakage Current	V <sub>DS</sub> =0V, V <sub>GS</sub> =±20V			±100	nA
I <sub>DSS</sub>	Drain-Source Leakage Current	V <sub>DS</sub> =-40V, V <sub>GS</sub> =0V			-1	uA
		V <sub>DS</sub> =-32V, V <sub>GS</sub> =0V T <sub>J</sub> =125°C			-10	
I <sub>S</sub>	Continuous Source Current	V <sub>G</sub> =V <sub>D</sub> =0V, Force Current			-16	A
I <sub>SM</sub>	Pulsed Source Current				-32	A
R <sub>DS(on)</sub>	Drain-Source On-Resistance	V <sub>GS</sub> =-10V, I <sub>D</sub> =-10A		37	45	mΩ
		V <sub>GS</sub> =-4.5V, I <sub>D</sub> =-6A		57	68	
g <sub>FS</sub>	Forward Transconductance	V <sub>DS</sub> =-10V, I <sub>D</sub> =-5A		7		S
V <sub>SD</sub>	Diode Forward Voltage	I <sub>S</sub> =-1A, V <sub>GS</sub> =0V			-1	V

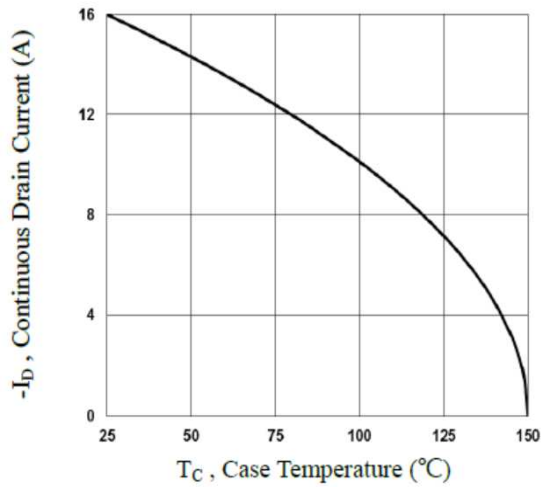
## Electrical Characteristics (Continue)

Symbol	Parameter	Conditions	Min	Typ	Max	Unit
<b>Dynamic</b>						
Q <sub>g</sub>	Total Gate Charge <sup>3,4</sup>	V <sub>DS</sub> =-20V, V <sub>GS</sub> =-4.5V, I <sub>D</sub> =-5A		8.2	16	nC
Q <sub>gs</sub>	Gate-Source Charge <sup>3,4</sup>			3.0	6	
Q <sub>gd</sub>	Gate-Drain Charge <sup>3,4</sup>			2.5	5	
C <sub>iss</sub>	Input Capacitance	V <sub>DS</sub> =-25V, V <sub>GS</sub> =0V, f=1MHz		825	1480	pF
C <sub>oss</sub>	Output Capacitance			68	130	
C <sub>rss</sub>	Reverse Transfer Capacitance			50	100	
t <sub>d(on)</sub>	Turn-On Time <sup>3,4</sup>	V <sub>DD</sub> =-20V, I <sub>D</sub> =-1A, V <sub>GS</sub> =-10V, R <sub>G</sub> =6Ω		6.3	12	ns
t <sub>r</sub>	Rise Time <sup>3,4</sup>			7.2	14	
t <sub>d(off)</sub>	Turn-Off Time <sup>3,4</sup>			46	80	
t <sub>f</sub>	Fall Time <sup>3,4</sup>			14	27	

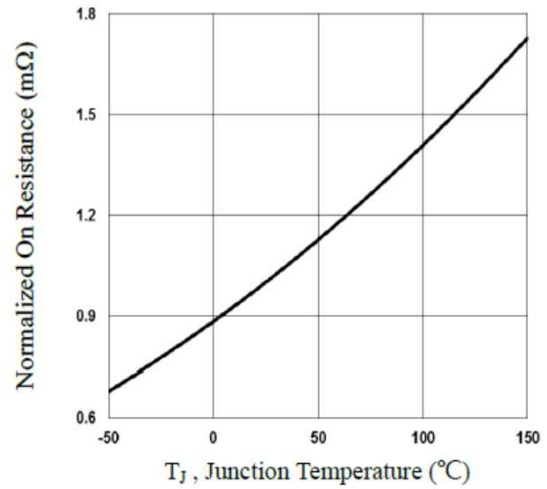
Note :

1. Repetitive Rating : Pulsed width limited by maximum junction temperature.
2. V<sub>DD</sub>=25V, V<sub>GS</sub>=10V, L=0.1mH, I<sub>AS</sub>=25A., Starting T<sub>J</sub>=25°C
3. The data tested by pulsed , pulse width ≤ 300us , duty cycle ≤ 2%.
4. Essentially independent of operating temperature.

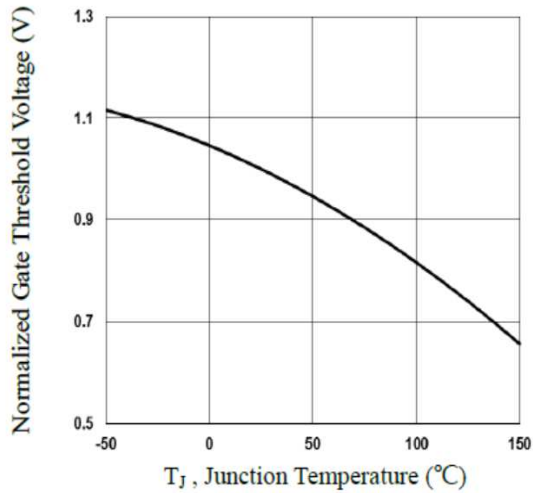
## Typical Performance Characteristics



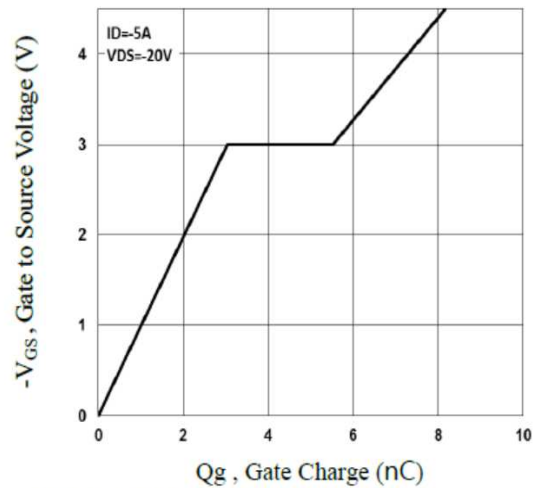
**Fig.1 Continuous Drain Current vs.  $T_c$**



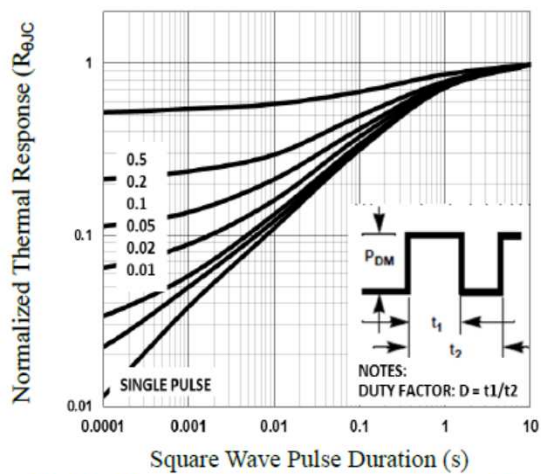
**Fig.2 Normalized  $R_{DS(on)}$  vs.  $T_j$**



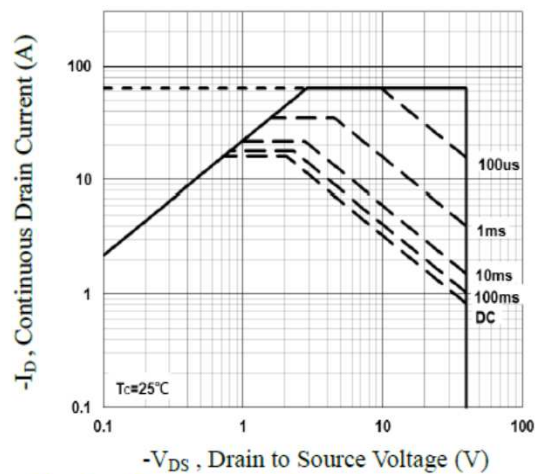
**Fig.3 Normalized  $V_{th}$  vs.  $T_j$**



**Fig.4 Gate Charge Waveform**

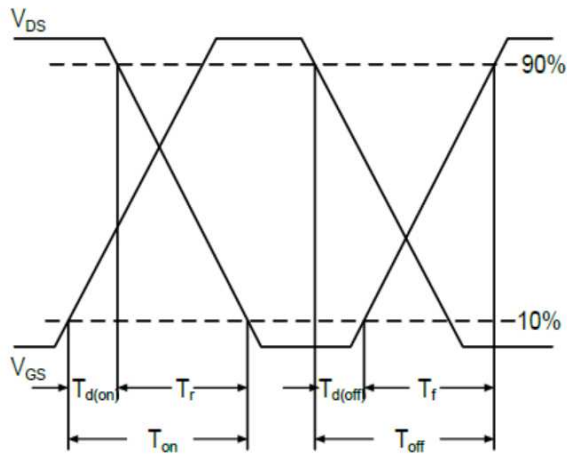


**Fig.5 Normalized Transient Impedance**

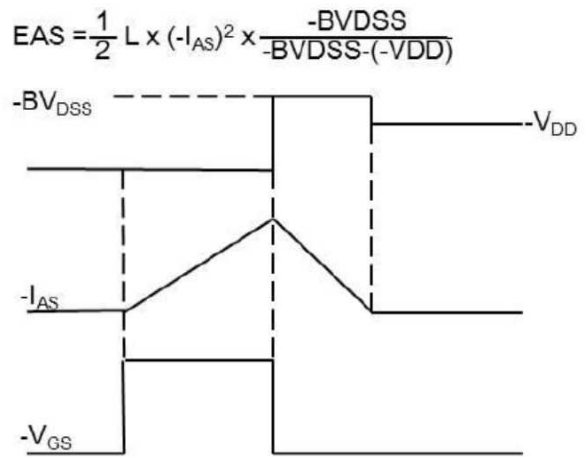


**Fig.6 Maximum Safe Operation Area**

## Typical Performance Characteristics (Continue)



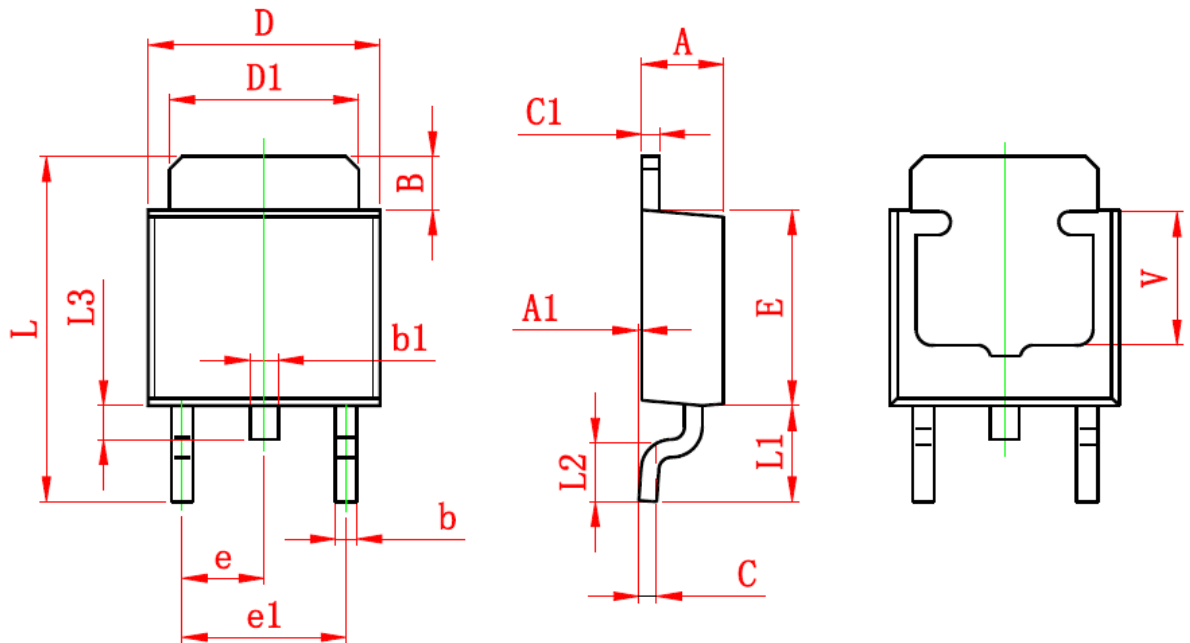
**Fig.7 Switching Time Waveform**



**Fig.8 EAS Waveform**

Package Dimension

TO-252-2L









Dimensions				
SYMBOL	Millimeters		Inches	
	MIN	MAX	MIN	MAX
A	2.200	2.400	0.087	0.094
A1	0.000	0.127	0.000	0.005
B	1.350	1.650	0.053	0.065
b	0.500	0.700	0.020	0.028
b1	0.700	0.900	0.028	0.035
C	0.430	0.580	0.017	0.023
C1	0.430	0.580	0.017	0.023
D	6.350	6.650	0.250	0.262
D1	5.200	5.400	0.205	0.213
E	5.400	5.700	0.213	0.224
e	2.300 TYP.		0.091 TYP.	
e1	4.500	4.700	0.177	0.185
L	9.500	9.900	0.374	0.390
L1	2.550	2.900	0.100	0.114
L2	1.400	1.780	0.055	0.070
L3	0.600	0.900	0.024	0.035
V	3.800 REF.		0.150 REF.	

## NOTICE

Information furnished is believed to be accurate and reliable. However Globaltech Semiconductor assumes no responsibility for the consequences of use of such information nor for any infringement of patents or other rights of third parties, which may result from its use. No license is granted by implication or otherwise under any patent or patent rights of Globaltech Semiconductor. Specifications mentioned in this publication are subject to change without notice. This publication supersedes and replaces all information without express written approval of Globaltech Semiconductor.

## CONTACT US

GS Headquarter	
	4F.,No.43-1,Lane11,Sec.6,Minquan E.Rd Neihu District Taipei City 114, Taiwan (R.O.C)
	886-2-2657-9980
	886-2-2657-3630
	sales_twn@gs-power.com

RD Division	
	824 Bolton Drive Milpitas. CA. 95035
	1-408-457-0587