

GSM4904Z

40V N-Channel MOSFETs

Product Description

These N-Channel enhancement mode power field effect transistors are using trench DMOS technology. This advanced technology has been especially tailored to minimize on-state resistance, provide superior switching performance, and withstand high energy pulse in the avalanche and commutation mode.

These devices are well suited for high efficiency fast switching applications.

Features

- 40V, 70A, $R_{DS(ON)}=5.5m\Omega@V_{GS}=10V$
- Improved dv/dt capability
- Fast switching
- Green Device Available

Applications

- Load Switch
- LED applications
- Notebook
- Hand-Held Device

Packages & Pin Assignments

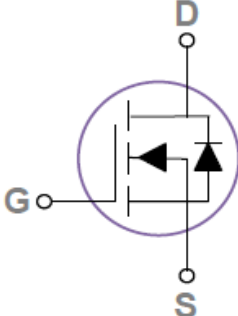
GSM4904ZFF (DFN3X3-8L)		
 <p>Top View</p>		
		
Pin No	Symbol	Description
1,2,3	S	Source
4	G	Gate
5,6,7,8	D	Drain

Ordering Information

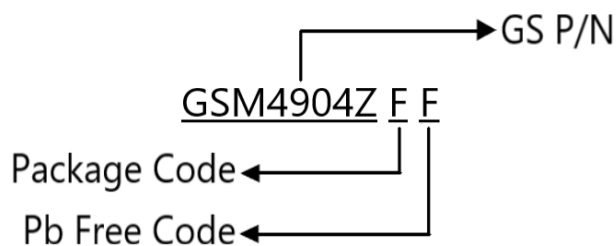

Part Number	Package	Quantity
GSM4904ZFF	DFN3x3-8L	5000pcs

Marking Information

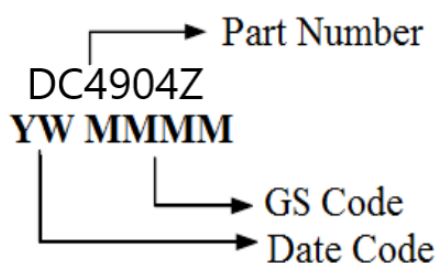

Absolute Maximum Ratings

$T_C=25^{\circ}\text{C}$ Unless otherwise noted

Symbol	Parameter	Typical	Unit
V_{DS}	Drain-Source Voltage	40	V
V_{GS}	Gate-Source Voltage	± 20	V
I_D	Continuous Drain Current	$T_C=25^{\circ}\text{C}$	70
		$T_C=100^{\circ}\text{C}$	44.3
I_{DM}	Pulsed Drain Current ¹	280	A
P_D	Power Dissipation ($T_C=25^{\circ}\text{C}$)	52	W
	Power Dissipation (Derate above 25°C)	0.42	W/ $^{\circ}\text{C}$
T_J	Operating Junction Temperature Range	-55 to +150	$^{\circ}\text{C}$
T_{STG}	Storage Temperature Range	-55 to +150	$^{\circ}\text{C}$
$R_{\theta JA}$	Thermal Resistance-Junction to Ambient	62	$^{\circ}\text{C}/\text{W}$
$R_{\theta JC}$	Thermal Resistance-Junction to Case	2.4	$^{\circ}\text{C}/\text{W}$

Electrical Characteristics

T_J=25°C Unless otherwise noted

Symbol	Parameter	Conditions	Min	Typ	Max	Unit
Static						
V _{(BR)DSS}	Drain-Source Breakdown Voltage	V _{GS} =0V, I _D =250uA	40			V
ΔBV _{DSS} /ΔT _J	BV _{DSS} Temperature Coefficient	Reference to 25°C, I _D =1mA		0.03		V/°C
V _{GS(th)}	Gate Threshold Voltage	V _{DS} =V _{GS} , I _D =250uA	1.0	1.6	2.5	V
ΔV _{GS(th)}	V _{GS(th)} Temperature Coefficient			-5		mV/°C
I _{GSS}	Gate-Source Leakage Current	V _{DS} =0V, V _{GS} =±20V			±100	nA
I _{DSS}	Drain-Source Leakage Current	V _{DS} =40V, V _{GS} =0V T _J =25°C			1	uA
		V _{DS} =32V, V _{GS} =0V, T _J =125°C			10	
I _S	Continuous Source Current	V _G =V _D =0V, Force Current			70	A
I _{SM}	Pulsed Source Current				140	
R _{DS(on)}	Drain-Source On-Resistance	V _{GS} =10V, I _D =20A		4.2	5.5	mΩ
		V _{GS} =4.5V, I _D =10A,		5.3	7	
g _{FS}	Forward Transconductance	V _{DS} =10V, I _D =10A		16		S
V _{SD}	Diode Forward Voltage	V _{GS} =0V, I _S =1A			1	V
Dynamic						
Q _g	Total Gate Charge ^{2,3}	V _{DS} =32V, V _{GS} =4.5V, I _D =10A		25	50	nC
Q _{gs}	Gate-Source Charge ^{2,3}			6.4	13	
Q _{gd}	Gate-Drain Charge ^{2,3}			12.1	24	
C _{iss}	Input Capacitance	V _{DS} =25V, V _{GS} =0V, f=1MHz		2410	3600	pF
C _{oss}	Output Capacitance			233	400	
C _{rss}	Reverse Transfer Capacitance			152	230	
t _{d(on)}	Turn-On Time ^{2,3}	V _{DD} =20V, I _D =1A, V _{GS} =10V, R _G =3.3Ω		14.2	28	ns
t _r	Rise Time ^{2,3}			18.3	36	
t _{d(off)}	Turn-Off Time ^{2,3}			38.8	76	
t _f	Fall Time ^{2,3}			13.9	28	
R _g	Gate resistance	V _{GS} =0V, V _{DS} =0V, F=1MHz		1.6	3.2	Ω

Note :

1. Repetitive Rating : Pulsed width limited by maximum junction temperature.
2. The data tested by pulsed , pulse width ≤ 300us , duty cycle ≤ 2%.
3. Essentially independent of operating temperature.

Typical Performance Characteristics

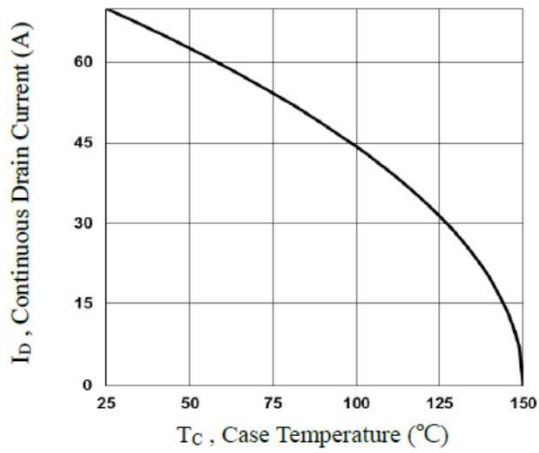

Fig.1 Continuous Drain Current vs. T_c

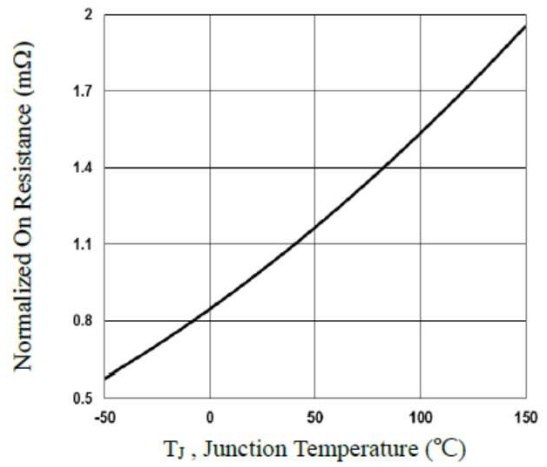

Fig.2 Normalized $R_{DS(on)}$ vs. T_j

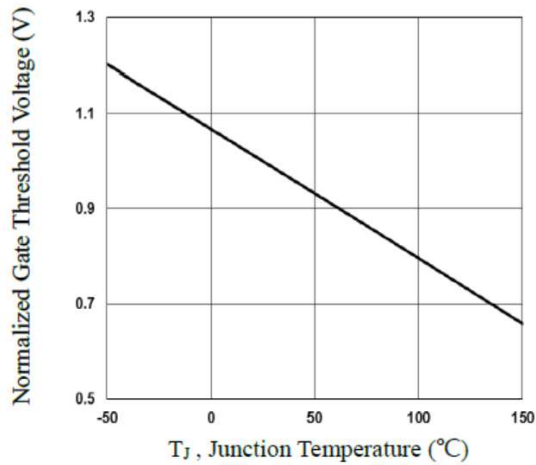

Fig.3 Normalized V_{th} vs. T_j

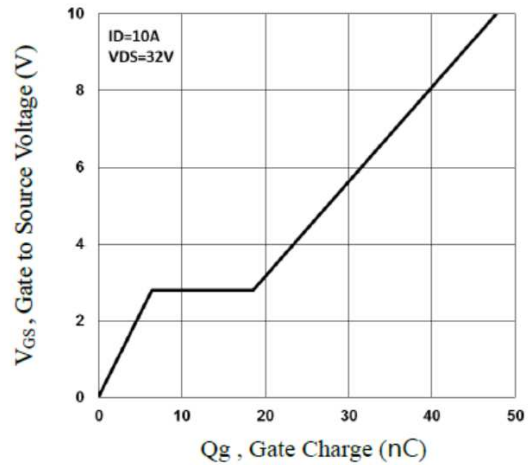

Fig.4 Gate Charge Waveform

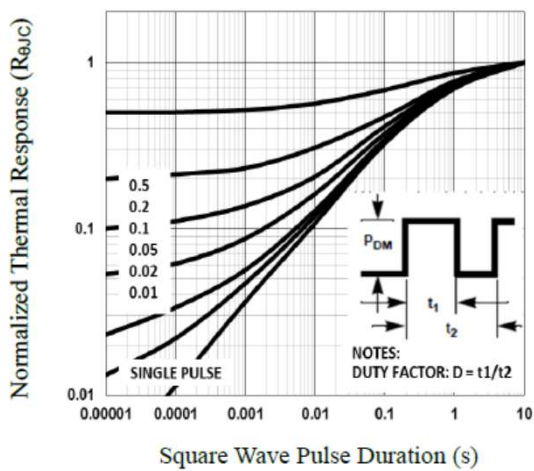

Fig.5 Normalized Transient Impedance

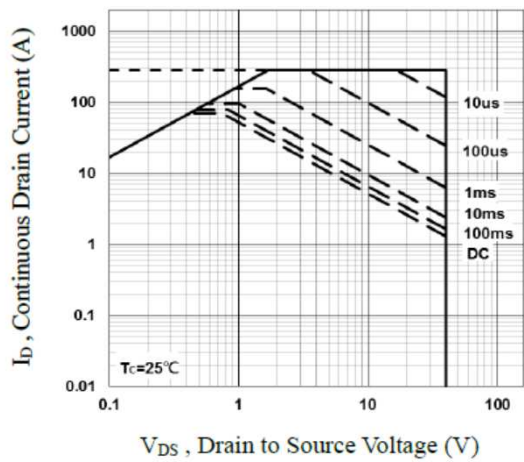

Fig.6 Maximum Safe Operation Area

Typical Performance Characteristics (Continue)

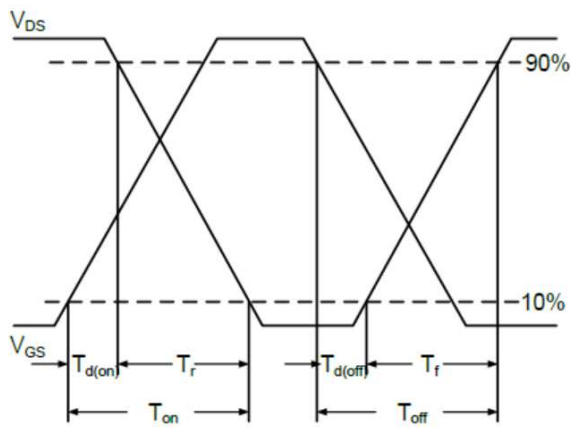

Fig.7 Switching Time Waveform

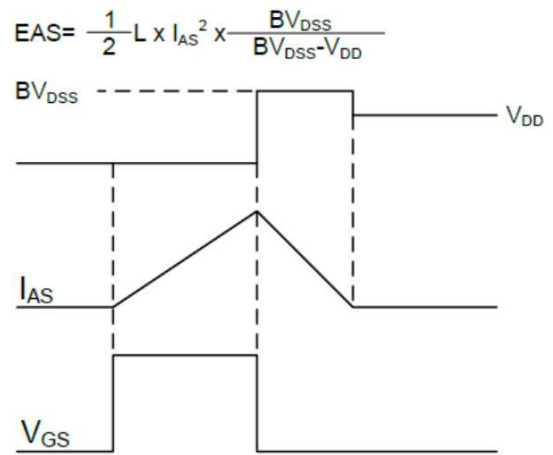
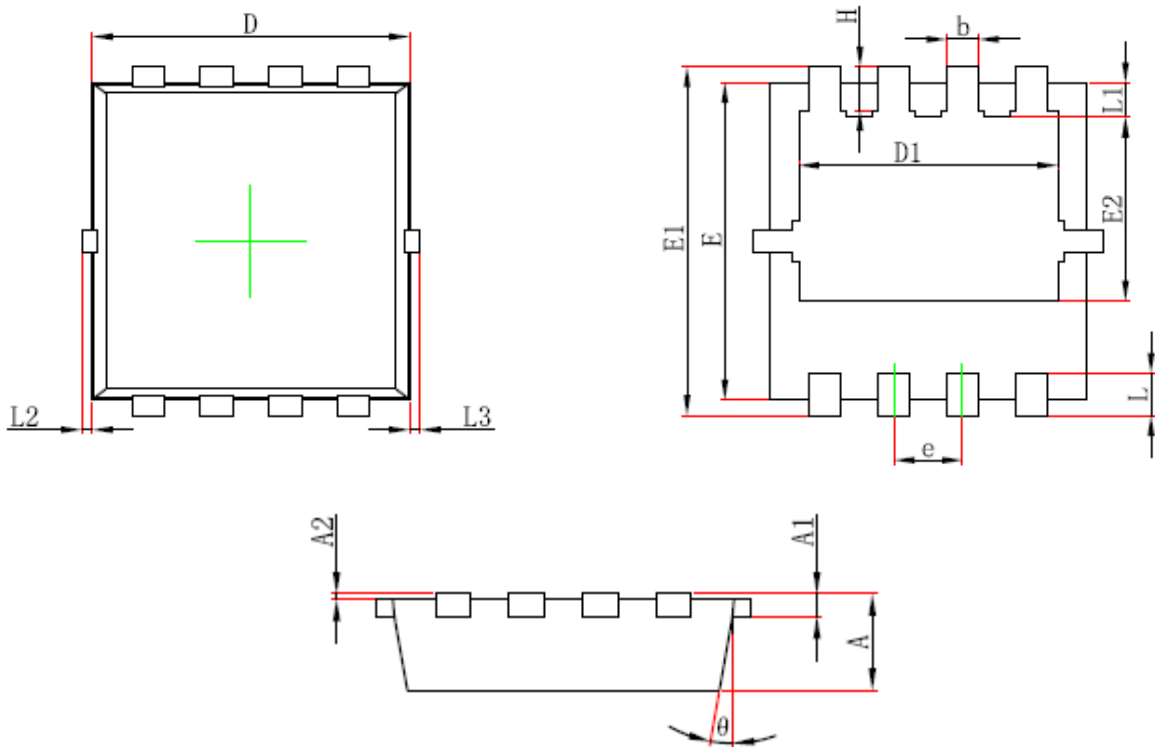

Fig.8 EAS Waveform

Package Dimension

DFN3X3-8L







Dimensions



Symbol	Millimeters		Inches	
	Min	Max	Min	Max
A	0.650	0.850	0.026	0.033
A1	0.152 REF.		0.006 REF.	
A2	0~0.05		0~0.002	
D	2.900	3.100	0.114	0.122
D1	2.300	2.600	0.091	0.102
E	2.900	3.100	0.114	0.122
E1	3.150	3.450	0.124	0.136
E2	1.535	1.935	0.060	0.076
b	0.200	0.400	0.008	0.016
e	0.550	0.750	0.022	0.030
L	0.300	0.500	0.012	0.020
L1	0.180	0.480	0.007	0.019
L2	0~0.100		0~0.004	
L3	0~0.100		0~0.004	
H	0.315	0.515	0.012	0.020
θ	9°	13°	9°	13°

NOTICE

Information furnished is believed to be accurate and reliable. However Globaltech Semiconductor assumes no responsibility for the consequences of use of such information nor for any infringement of patents or other rights of third parties, which may result from its use. No license is granted by implication or otherwise under any patent or patent rights of Globaltech Semiconductor. Specifications mentioned in this publication are subject to change without notice. This publication supersedes and replaces all information without express written approval of Globaltech Semiconductor.

CONTACT US

GS Headquarter	
	4F.,No.43-1,Lane11,Sec.6,Minquan E.Rd Neihu District Taipei City 114, Taiwan (R.O.C)
	886-2-2657-9980
	886-2-2657-3630
	sales_twn@gs-power.com

RD Division	
	824 Bolton Drive Milpitas. CA. 95035
	1-408-457-0587