

GSM3911

30V P-Channel MOSFET

Product Description

These P-Channel enhancement mode power field effect transistors are using trench DMOS technology. This advanced technology has been especially tailored to minimize on-state resistance, provide superior switching performance, and withstand high energy pulse in the avalanche and commutation mode.

These devices are well suited for high efficiency fast switching applications.

Features

- -30V,-4.5A, $R_{DS(ON)} = 55m\Omega @ V_{GS} = -10V$
- Fast switching
- Green Device Available
- Suit for -4.5V Gate Drive Applications

Applications

- Notebook
- Load Switch
- Battery Protection
- Hand-held Instruments

Packages & Pin Assignments

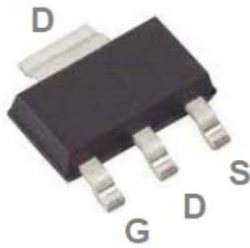
GSM3911XF (SOT-223)		
		
Pin No	Symbol	Description
1	G	Gate
2	D	Drain
3	S	Source

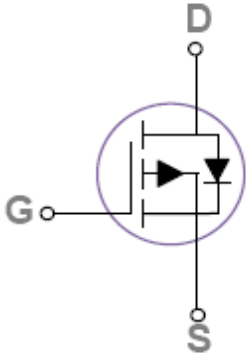

Ordering & Marking Information

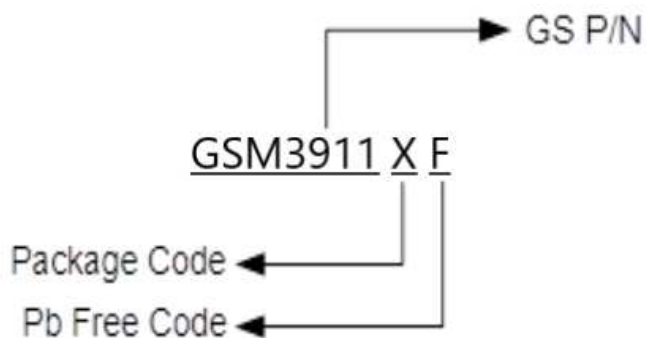

Part Number	Package	Quantity
GSM3911XF	SOT-223	2500pcs

Marking Information

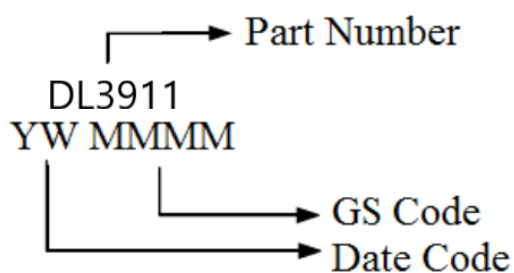

Absolute Maximum Ratings

$T_C=25^{\circ}\text{C}$ Unless otherwise noted

Symbol	Parameter	Typical	Unit
V_{DS}	Drain-Source Voltage	-30	V
V_{GS}	Gate-Source Voltage	± 20	V
I_D	Continuous Drain Current	$T_C=25^{\circ}\text{C}$	-4.5
		$T_C=100^{\circ}\text{C}$	-2.85
I_{DM}	Pulsed Drain Current ¹	-18	A
P_D	Power Dissipation	1.78	W
	Power Dissipation-Derate above 25°C	0.014	W/ $^{\circ}\text{C}$
T_J	Operating Junction Temperature Range	-55 to +150	$^{\circ}\text{C}$
T_{STG}	Storage Temperature Range	-55 to +150	$^{\circ}\text{C}$
$R_{\theta JA}$	Thermal Resistance-Junction to Ambient	70	$^{\circ}\text{C}/\text{W}$
$R_{\theta JC}$	Thermal Resistance-Junction to Case	45	$^{\circ}\text{C}/\text{W}$

Electrical Characteristics

T_J=25°C Unless otherwise noted

Symbol	Parameter	Conditions	Min	Typ	Max	Unit
Static						
V _{(BR)DSS}	Drain-Source Breakdown Voltage	V _{GS} =0V, I _D =-250uA	-30			V
$\frac{\Delta V_{(BR)DSS}}{\Delta T_J}$	V _{(BR)DSS} Temperature Coefficient	Reference to 25°C, I _D =-1mA		-0.03		V/°C
V _{GS(th)}	Gate Threshold Voltage	V _{DS} =V _{GS} , I _D =-250uA	-1.2	-1.6	-2.2	V
$\Delta V_{GS(th)}$	V _{GS(th)} Temperature Coefficient			4		mV/°C
I _{GSS}	Gate-Source Leakage Current	V _{DS} =0V, V _{GS} =±20V			±100	nA
I _{DSS}	Drain-Source Leakage Current	V _{DS} =-30V, V _{GS} =0V			-1	uA
		V _{DS} =-24V, V _{GS} =0V T _J =125°C			-10	
I _S	Continuous Source Current	V _G =V _D =0V, Force Current			-4.1	A
I _{SM}	Pulsed Source Current				-8.2	A
R _{DS(on)}	Drain-Source On-Resistance	V _{GS} =-10V, I _D =-4A		45	55	mΩ
		V _{GS} =-4.5V, I _D =-3A		65	85	
g _{FS}	Forward Transconductance	V _{DS} =-10V, I _D =-3A		3.5		S
V _{SD}	Diode Forward Voltage	I _S =-1A, V _{GS} =0V			-1	V

Electrical Characteristics (Continue)

Symbol	Parameter	Conditions	Min	Typ	Max	Unit
Dynamic						
Q _g	Total Gate Charge ^{2,3}	V _{DS} =-15V, V _{GS} =-4.5V, I _D =-3A		5.1	7	nC
Q _{gs}	Gate-Source Charge ^{2,3}			2	3	
Q _{gd}	Gate-Drain Charge ^{2,3}			2.2	4	
C _{iss}	Input Capacitance	V _{DS} =-15V, V _{GS} =0V, f=1MHz		560	810	pF
C _{oss}	Output Capacitance			55	80	
C _{rss}	Reverse Transfer Capacitance			40	60	
t _{d(on)}	Turn-On Time ^{2,3}	V _{DD} =-15V, I _D =-1A, V _{GS} =-10V, R _G =6Ω		3.4	6	ns
t _r	Rise Time ^{2,3}			10.8	21	
t _{d(off)}	Turn-Off Time ^{2,3}			26.9	51	
t _f	Fall Time ^{2,3}			6.9	13	

Note :

1. Repetitive Rating : Pulsed width limited by maximum junction temperature.
2. The data tested by pulsed , pulse width ≤ 300us , duty cycle ≤ 2%.
3. Essentially independent of operating temperature.

Typical Performance Characteristics

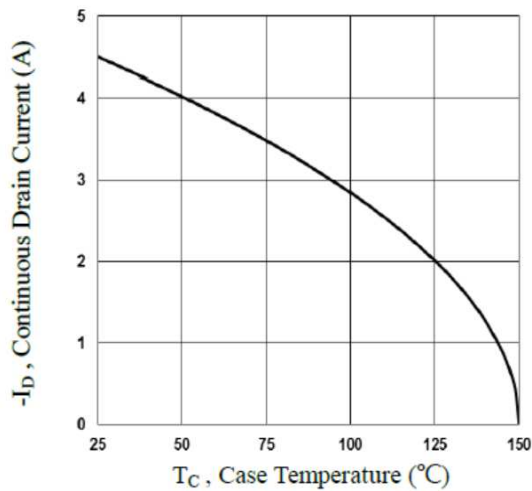

Fig.1 Continuous Drain Current vs. T_c

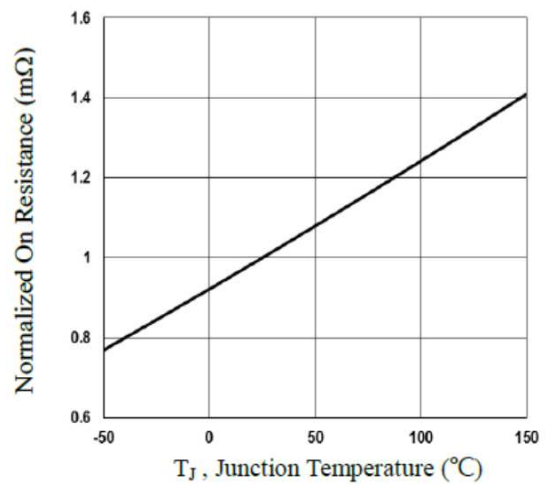

Fig.2 Normalized $R_{DS(on)}$ vs. T_j

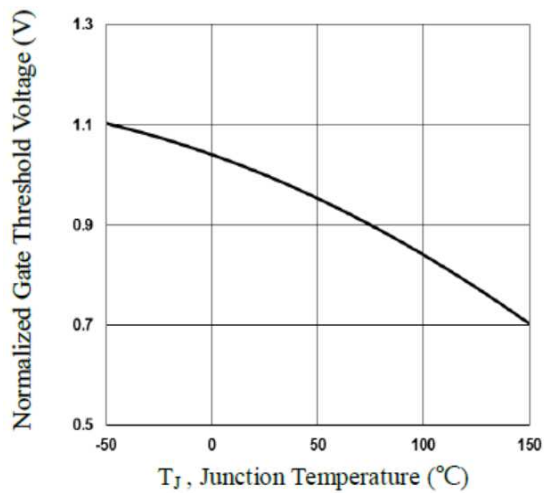

Fig.3 Normalized V_{th} vs. T_j

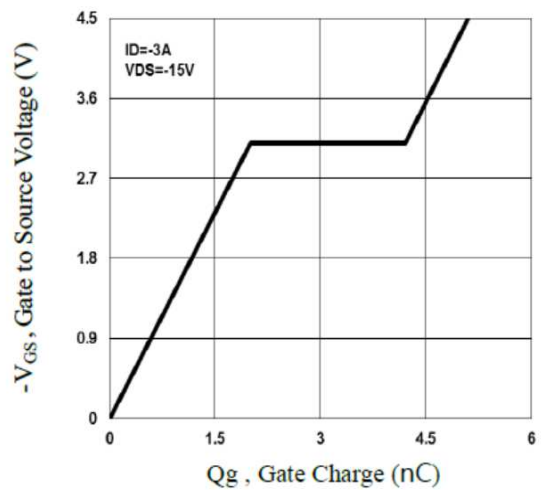

Fig.4 Gate Charge Waveform

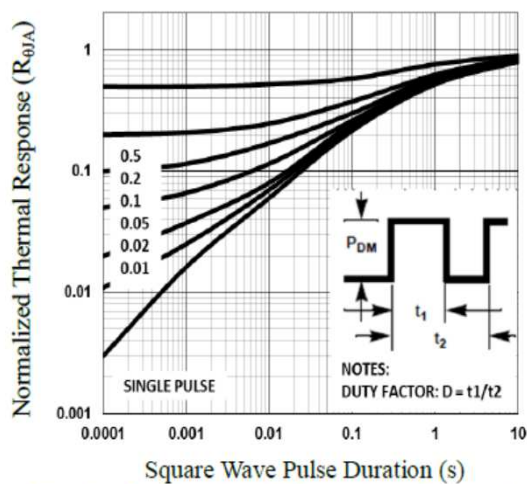

Fig.5 Normalized Transient Impedance

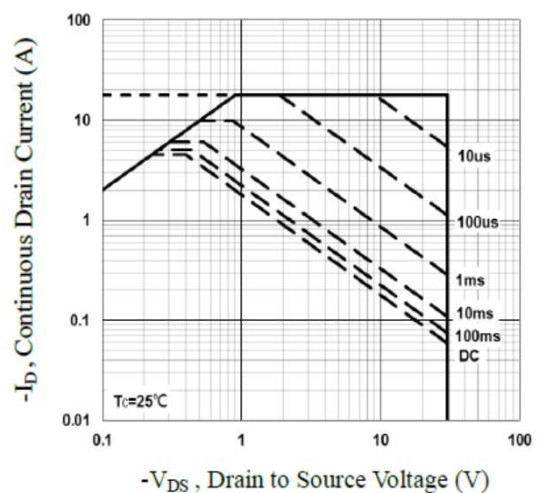

Fig.6 Maximum Safe Operation Area

Typical Performance Characteristics (Continue)

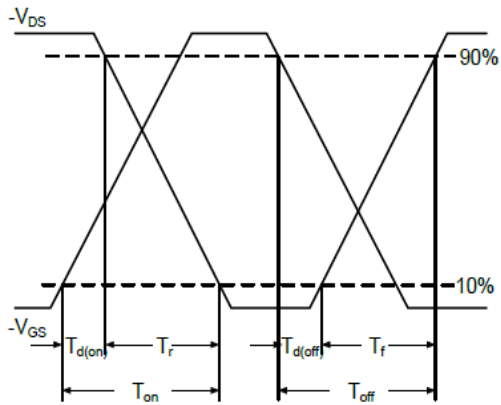

Fig.7 Switching Time Waveform

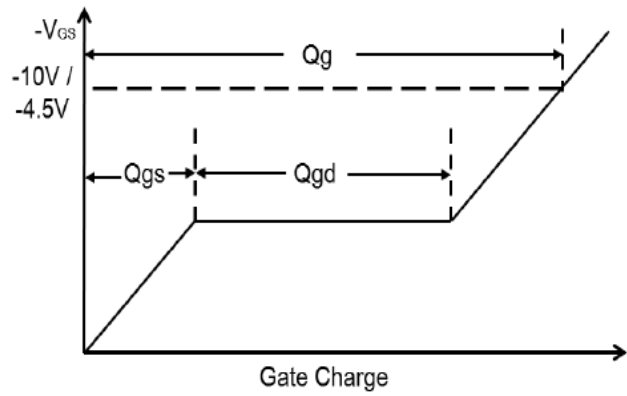
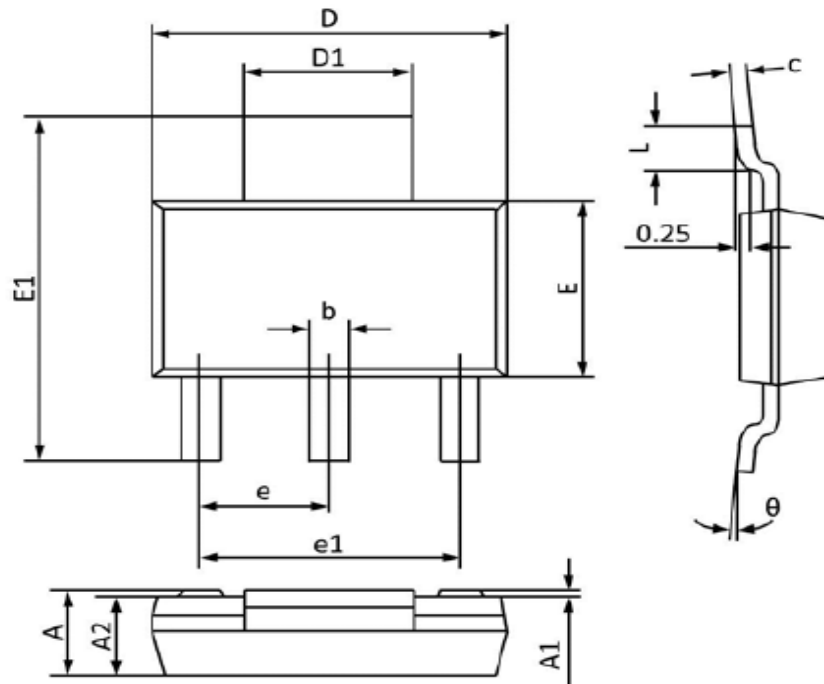

Fig.8 Gate Charge Waveform

Package Dimension

SOT-223







Dimensions



Symbol	Millimeters		Inches	
	Min	Max	Min	Max
A	1.520	1.800	0.060	0.071
A1	0.000	0.100	0.000	0.004
A2	1.500	1.700	0.059	0.067
b	0.660	0.820	0.026	0.032
c	0.250	0.350	0.010	0.014
D	6.200	6.400	0.244	0.252
D1	2.900	3.100	0.114	0.122
E	3.300	3.700	0.130	0.146
E1	6.830	7.070	0.269	0.278
e	2.300 (BSC)		0.091 (BSC)	
e1	4.500	4.700	0.177	0.185
L	0.900	1.150	0.035	0.045
θ	0°	10°	0°	10°

NOTICE

Information furnished is believed to be accurate and reliable. However Globaltech Semiconductor assumes no responsibility for the consequences of use of such information nor for any infringement of patents or other rights of third parties, which may result from its use. No license is granted by implication or otherwise under any patent or patent rights of Globaltech Semiconductor. Specifications mentioned in this publication are subject to change without notice. This publication supersedes and replaces all information without express written approval of Globaltech Semiconductor.

CONTACT US

GS Headquarter	
	4F.,No.43-1,Lane11,Sec.6,Minquan E.Rd Neihu District Taipei City 114, Taiwan (R.O.C)
	886-2-2657-9980
	886-2-2657-3630
	sales_twn@gs-power.com

RD Division	
	824 Bolton Drive Milpitas. CA. 95035
	1-408-457-0587