

GSM3620KX

30V N-Channel MOSFETs

Product Description

These N-Channel enhancement mode power field effect transistors are using trench DMOS technology. This advanced technology has been especially tailored to minimize on-state resistance, provide superior switching performance, and withstand high energy pulse in the avalanche and commutation mode.

These devices are well suited for high efficiency fast switching applications.

Features

- 30V, 600mA, $R_{DS(ON)}=500m\Omega@V_{GS}=4.5V$
- Improved dv/dt capability
- Fast switching
- Suit for 2.5V Gate Drive Applications
- Green Device Available

Applications

- Notebook
- Load Switch
- Battery Protection
- Hand-held Instruments

Packages & Pin Assignments

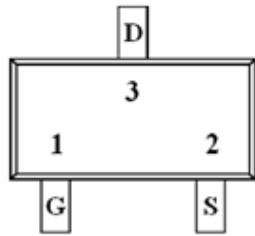
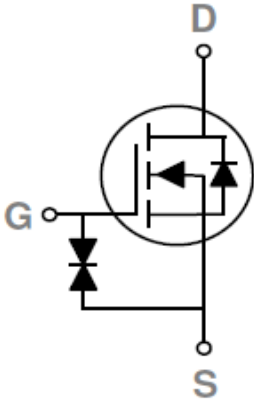
GSM3620KX7F (SOT-523)	
 <p>Top View</p>	
	
Pin	Description
1	Gate
2	Source
3	Drain

Ordering Information

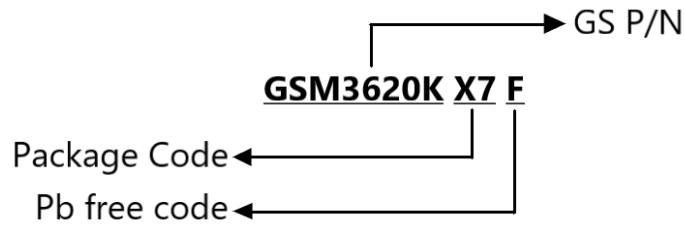

Part Number	Package	Part Marking	Quantity
GSM3620KX7F	SOT-523	OYM	3000pcs

Marking Information

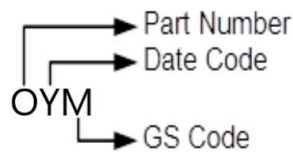

Absolute Maximum Ratings

$T_A=25^{\circ}\text{C}$ Unless otherwise noted

Symbol	Parameter	Typical	Unit
V_{DS}	Drain-Source Voltage	30	V
V_{GS}	Gate-Source Voltage	± 12	V
I_D	Continuous Drain Current	$T_A=25^{\circ}\text{C}$	600
		$T_A=70^{\circ}\text{C}$	460
I_{DM}	Pulsed Drain Current ¹	2.4	A
P_D	Power Dissipation ($T_A=25^{\circ}\text{C}$)	310	mW
	Power Dissipation (Derate above 25°C)	2.5	mW/ $^{\circ}\text{C}$
T_J	Operating Junction Temperature Range	-55 to +150	$^{\circ}\text{C}$
T_{STG}	Storage Temperature Range	-55 to +150	$^{\circ}\text{C}$
$R_{\theta JA}$	Thermal Resistance-Junction to Ambient	400	$^{\circ}\text{C}/\text{W}$

Note :

1. Repetitive Rating : Pulsed width limited by maximum junction temperature.

Electrical Characteristics

T_A=25°C Unless otherwise noted

Symbol	Parameter	Conditions	Min	Typ	Max	Unit
Static						
V _{(BR)DSS}	Drain-Source Breakdown Voltage	V _{GS} =0V, I _D =250μA	30	---	---	V
ΔBV _{DSS} /ΔT _J	BV _{DSS} Temperature Coefficient	Reference to 25°C, I _D =1mA	---	-0.03	---	V/°C
V _{GS(th)}	Gate Threshold Voltage	V _{DS} =V _{GS} , I _D =250μA	0.5	0.8	1.2	V
ΔV _{GS(th)}	V _{GS(th)} Temperature Coefficient		---	-1.74	---	mV/°C
I _{GSS}	Gate Leakage Current	V _{DS} =0V, V _{GS} =±12V	---	---	±20	nA
I _{DSS}	Drain-Source Leakage Current	V _{DS} =30V, V _{GS} =0V T _J =25°C	---	---	1	μA
		V _{DS} =24V, V _{GS} =0V, T _J =125°C	---	---	10	
I _S	Continuous Source Current	V _G =V _D =0V, Force Current	---	---	0.6	A
I _{SM}	Pulsed Source Current		---	---	1.2	
R _{DS(on)}	Drain-Source On-Resistance	V _{GS} =4.5V, I _D =0.3A	---	420	500	mΩ
		V _{GS} =2.5V, I _D =0.2A,	---	550	700	
g _{FS}	Forward Transconductance	V _{DS} =4V, I _D =0.3A	---	1	---	S
V _{SD}	Diode Forward Voltage	V _{GS} =0V, I _S =0.3A	---	---	1	V
Dynamic						
Q _g	Total Gate Charge ^{2,3}	V _{DS} =15V, V _{GS} =4.5V, I _D =0.3A	---	2.6	5.2	nC
Q _{gs}	Gate-Source Charge ^{2,3}		---	0.9	1.8	
Q _{gd}	Gate-Drain Charge ^{2,3}		---	0.6	1.2	
C _{iss}	Input Capacitance	V _{DS} =15V, V _{GS} =0V, f=1MHz	---	72.9	146	pF
C _{oss}	Output Capacitance		---	18.3	36.6	
C _{rss}	Reverse Transfer Capacitance		---	7.4	14.8	
t _{d(on)}	Turn-On Time ^{2,3}	V _{DD} =15V, I _D =0.3A, V _{GS} =4.5V, R _G =10Ω	---	5.5	11	ns
t _r	Rise Time ^{2,3}		---	4	8	
t _{d(off)}	Turn-Off Time ^{2,3}		---	14.5	29	
t _f	Fall Time ^{2,3}		---	6.5	13	

Note :

- The data tested by pulsed , pulse width ≤ 300us , duty cycle ≤ 2%.
- Essentially independent of operating temperature.

Typical Performance Characteristics

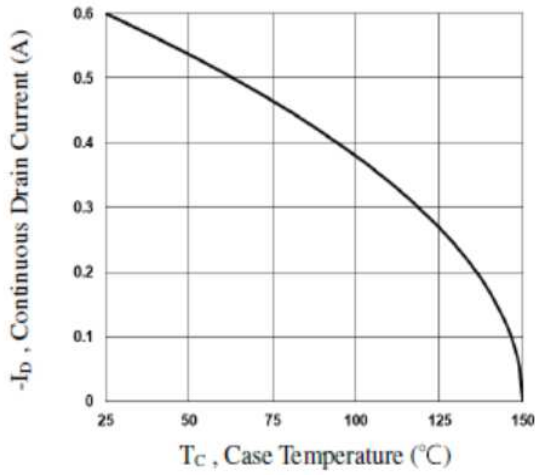

Fig.1 Continuous Drain Current vs. T_c

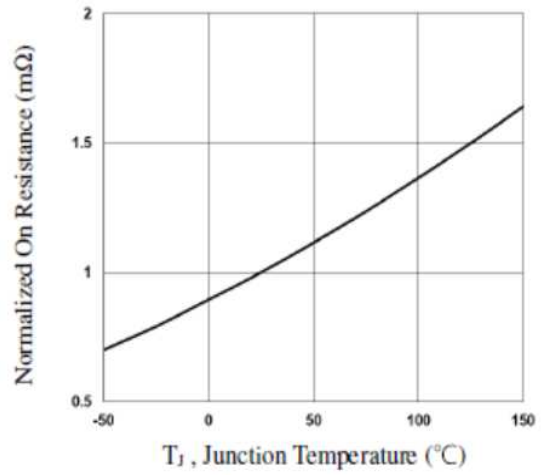

Fig.2 Normalized $R_{DS(on)}$ vs. T_j

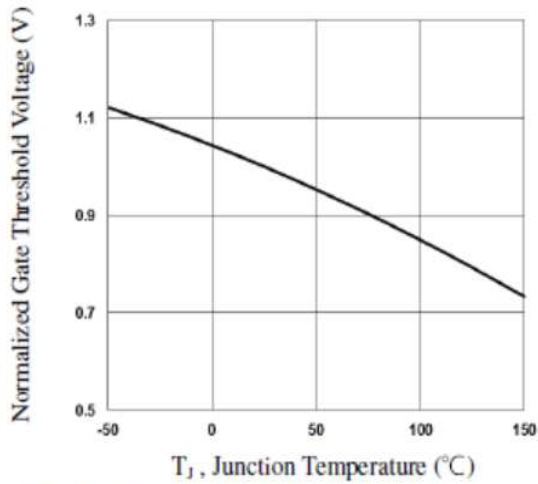

Fig.3 Normalized V_{th} vs. T_j

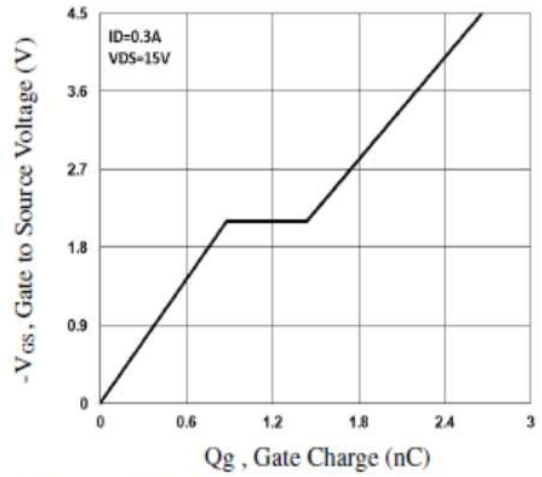

Fig.4 Gate Charge Waveform

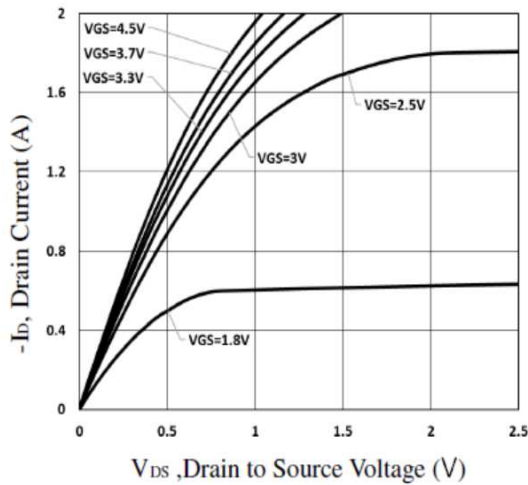

Fig.5 Typical Output Characteristics

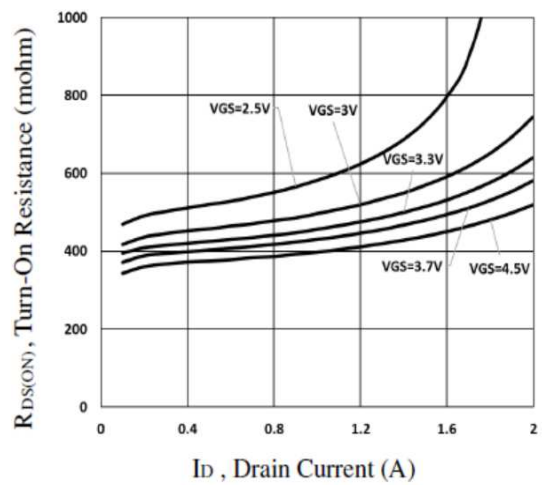

Fig.6 Turn-On Resistance vs. I_d

Typical Performance Characteristics (Continue)

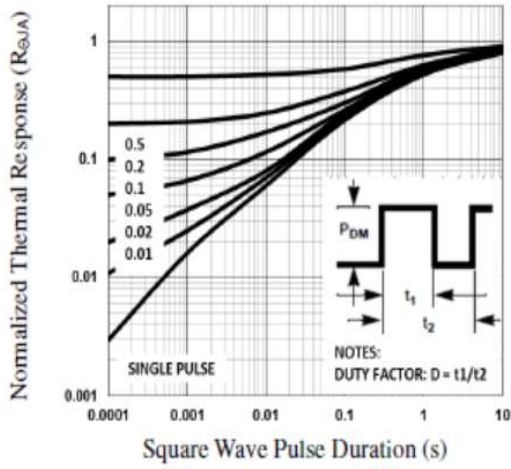

Fig.7 Normalized Transient Response

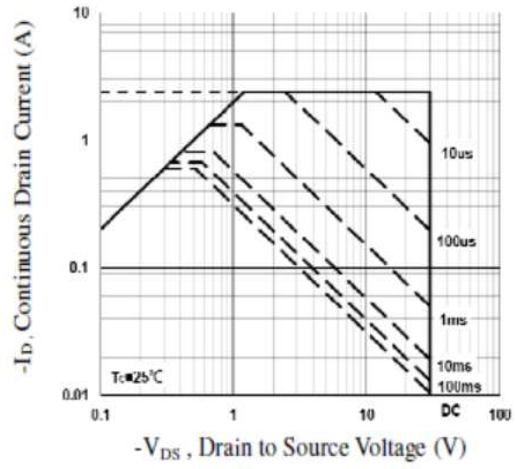

Fig.8 Maximum Safe Operation Area

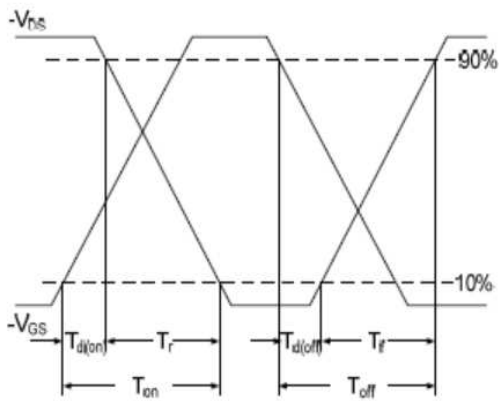

Fig.9 Switching Time Waveform

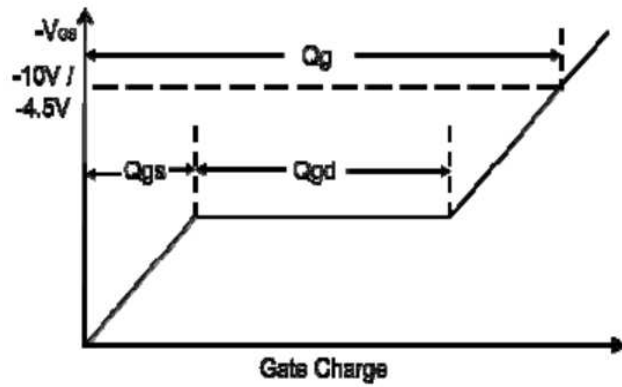
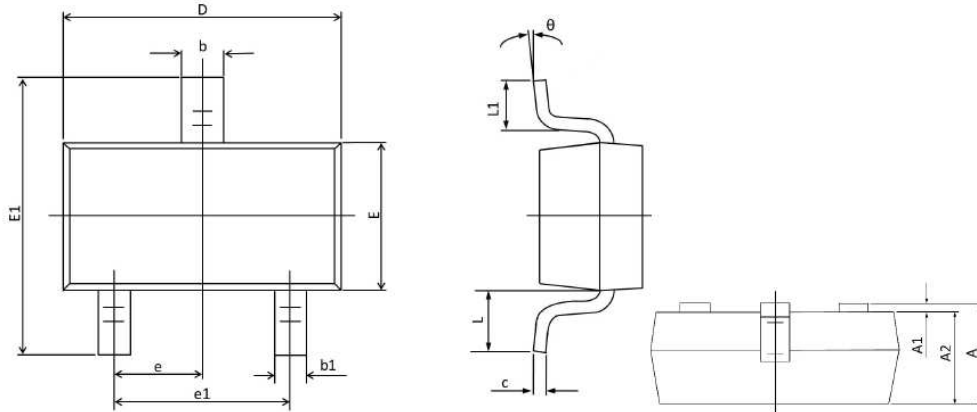

Fig.10 Gate Charge Waveform

Package Dimension

SOT-523









Dimensions				
SYMBOL	Millimeters		Inches	
	MAX	MIN	MAX	MIN
A	0.900	0.700	0.035	0.028
A1	0.100	0.000	0.004	0.000
A2	0.800	0.700	0.031	0.028
b	0.350	0.250	0.014	0.010
b1	0.250	0.150	0.010	0.006
c	0.200	0.100	0.008	0.004
D	1.750	1.500	0.069	0.059
E	0.900	0.700	0.035	0.028
E1	1.750	1.400	0.069	0.055
e	0.5TYP.		0.02TYP.	
e1	1.100	0.900	0.043	0.035
L	0.460	0.300	0.018	0.012
L1	0.460	0.260	0.018	0.010
θ	8°	0°	8°	0°

NOTICE

Information furnished is believed to be accurate and reliable. However Globaltech Semiconductor assumes no responsibility for the consequences of use of such information nor for any infringement of patents or other rights of third parties, which may result from its use. No license is granted by implication or otherwise under any patent or patent rights of Globaltech Semiconductor. Specifications mentioned in this publication are subject to change without notice. This publication supersedes and replaces all information without express written approval of Globaltech Semiconductor.

CONTACT US

GS Headquarter	
	4F.,No.43-1,Lane11,Sec.6,Minquan E.Rd Neihu District Taipei City 114, Taiwan (R.O.C)
	886-2-2657-9980
	886-2-2657-3630
	sales_twn@gs-power.com

RD Division	
	824 Bolton Drive Milpitas. CA. 95035
	1-408-457-0587