

GSM02P15

150V P-Channel Enhancement MOSFETs

General Description

These P-Channel enhancement mode power field effect transistors are using trench DMOS technology.

This advanced technology has been especially tailored to minimize on-state resistance, provide superior switching performance, and withstand high energy pulse in the avalanche and commutation mode.

These devices are well suited for high efficiency fast switching applications.

Features

- -150V/-1A, $R_{DS(ON)}=750m\Omega@V_{GS}=-1V$
- Improved dv/dt capability
- Fast switching
- Green Device Available

Applications

- Networking
- Load Switch
- LED applications

Packages & Pin Assignments

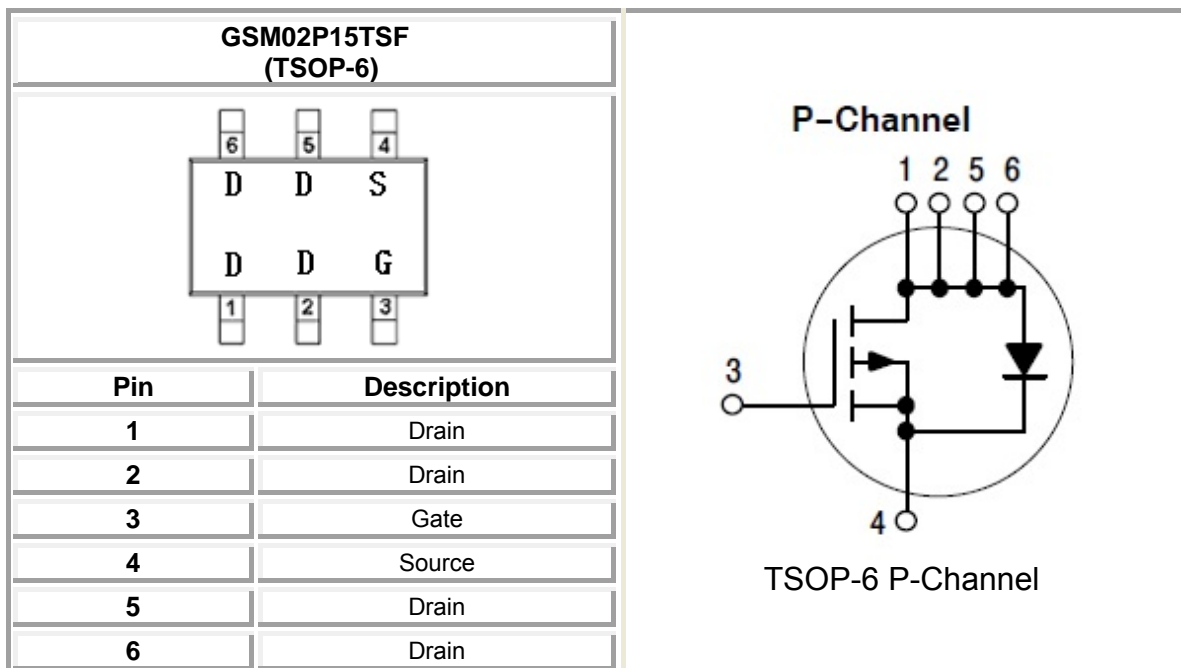

Ordering Information

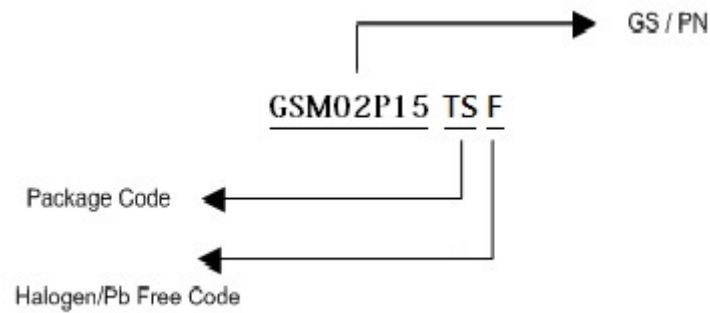

Part Number	Package	Quantity Reel
GSM02P15TSF	TSOP-6	3000 PCS

Marking Information

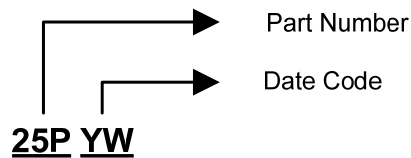

Absolute Maximum Ratings

($T_A=25^\circ\text{C}$ unless otherwise noted)

Symbol	Parameter	Typical	Unit
V_{DS}	Drain-Source Voltage	-150	V
V_{GS}	Gate-Source Voltage	± 20	V
I_D	Drain Current- Continuous ($T_A=25^\circ\text{C}$)	-1	A
	Drain Current- Continuous ($T_A=100^\circ\text{C}$)	-0.63	A
I_{DM}	Drain Current- Pulsed ¹	-4	A
P_D	Power Dissipation ($T_A=25^\circ\text{C}$)	1.56	W
	Power Dissipation –Derate above 25°C	0.012	W/ $^\circ\text{C}$
T_J	Operating Junction Temperature Range	-50 to 150	$^\circ\text{C}$
T_{STG}	Storage Temperature Range	-50 to 150	$^\circ\text{C}$

Thermal Characteristics

Symbol	Parameter	Typ.	Max	Unit
$R_{\theta JA}$	Thermal Resistance-Junction to ambient	---	80	$^\circ\text{C}/\text{W}$

Electrical Characteristics (T_A=25°C unless otherwise noted)

Off Characteristics

Symbol	Parameter	Conditions	Min	Typ	Max	Unit
Static						
V _{(BR)DSS}	Drain-Source Breakdown Voltage	V _{GS} =0V, I _D =250uA	-150	---	---	V
V _{GS(th)}	Gate Threshold Voltage	V _{GS} =V _{DS} , I _D =-250uA	-2	-3	-4	
I _{GSS}	Gate-Source Leakage Current	V _{DS} =0V, V _{GS} =±20V	---	---	±100	nA
I _{DSS}	Drain-Source Leakage Current	V _{DS} =-150V, V _{GS} =0V, T _J =25°C	---	---	-1	uA
		V _{DS} =-120V, V _{GS} =0V, T _J =125°C	---	---	-10	
R _{DS(on)}	Drain-Source On-Resistance	V _{GS} =10V, I _D =-1A	---	650	800	mΩ
		V _{GS} =6V, I _D =-0.5A	---	700	650	
G _{FS}	Forward Transconductance	V _{DS} =10V, I _D =3A	---	2	---	S
Dynamic						
C _{iss}	Input Capacitance	V _{DS} =-25V, V _{GS} =0V, F=1MHz	---	430	700	pF
C _{oss}	Output Capacitance		---	38	60	
C _{rss}	Reverse Transfer Capacitance		---	28	56	
Q _g	Total Gate Charge ^{2,3}	V _{DS} =-75V, V _{GS} =10V, I _D =-1A	---	4.4	8	nC
Q _{gs}	Gate-Source Charge ^{2,3}		---	0.7	2	
Q _{gd}	Gate-Drain Charge ^{2,3}		---	1.5	3	
t _{d(on)}	Turn-On Time ^{2,3}	V _{DD} =-75V, V _{GS} =-10V, R _G =10Ω, I _D =-1A,	---	12.5	20	ns
t _r			---	8.9	18	
t _{d(off)}	Turn-Off Time ^{2,3}		---	17.3	36	
t _f			---	11.5	24	
R _g	Gate Resistance		V _{GS} =0V, V _{DS} =0V, F=1MHz	---	30	

Drain-Source Diode Characteristics and Maximum Ratings

Symbol	Parameter	Conditions	Min.	Typ.	Max.	Unit
I _S	Continuous Source Current	V _G =V _D =0V, Force Current	---	---	-1	A
I _{SM}	Pulsed Source Current		---	---	-2	A
V _{SD}	Diode Forward Voltage	V _{GS} =0V, I _S =1A, T _J =25°C	---	---	-1	V

Note :

1. Repetitive Rating : Pulsed width limited by maximum junction temperature.
2. The data tested by pulsed , pulse width ≤ 300us , duty cycle ≤ 2%.
3. Essentially independent of operating temperature.

Typical Performance Characteristics

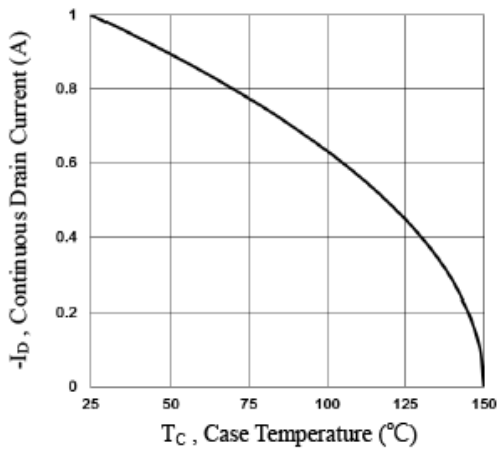

Fig.1 Continuous Drain Current vs. T_C

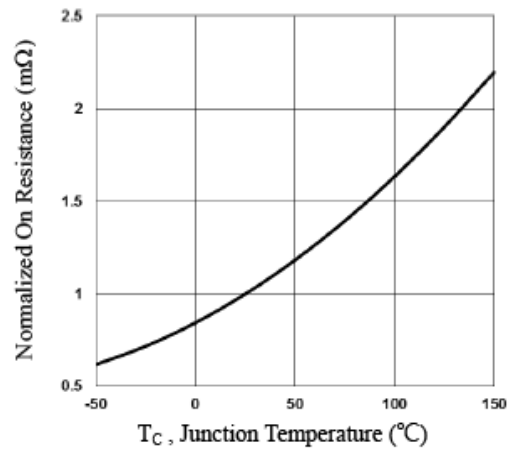

Fig.2 Continuous Drain Current vs. T_C

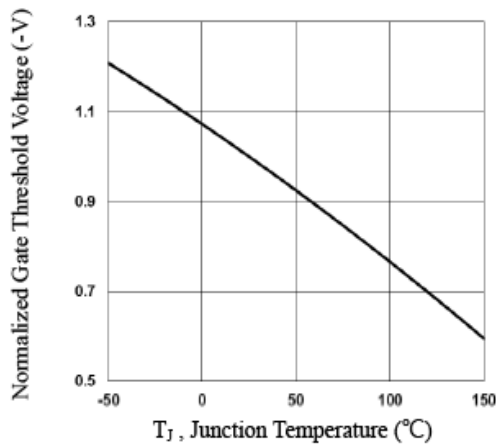

Fig.3 Normalized V_{th} vs. T_J

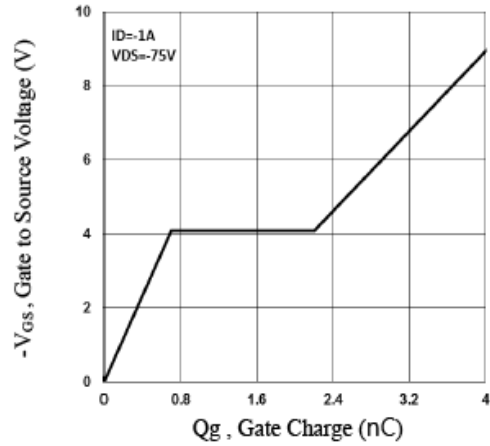

Fig.4 Gate Charge Waveform

Typical Performance Characteristics (Continue)

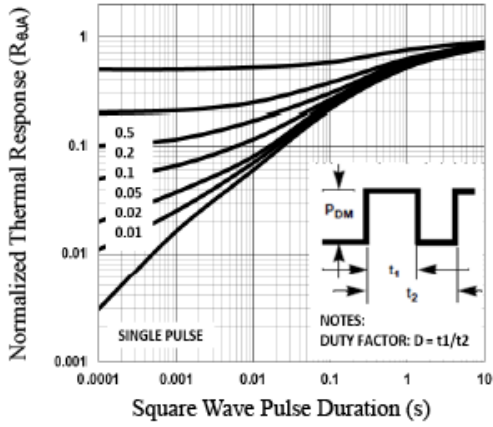

Fig.5 Normalized Transient Impedance

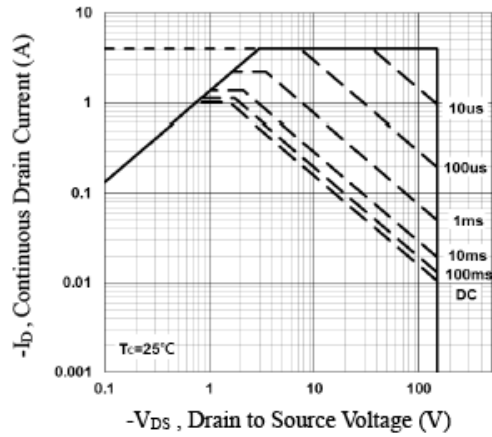

Fig.6 Maximum Safe Operation Area

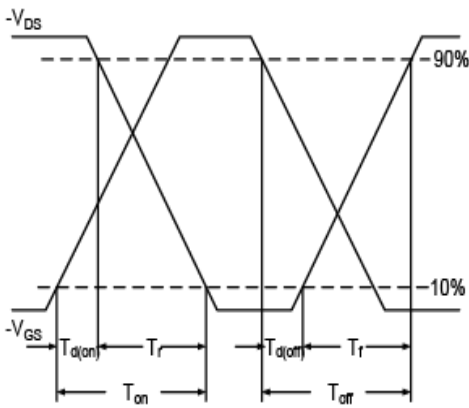

Fig.7 Switching Time Waveform

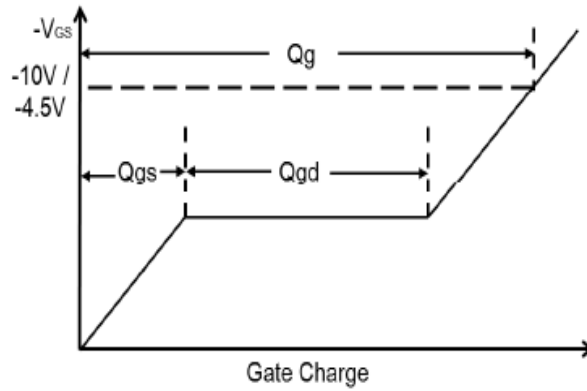
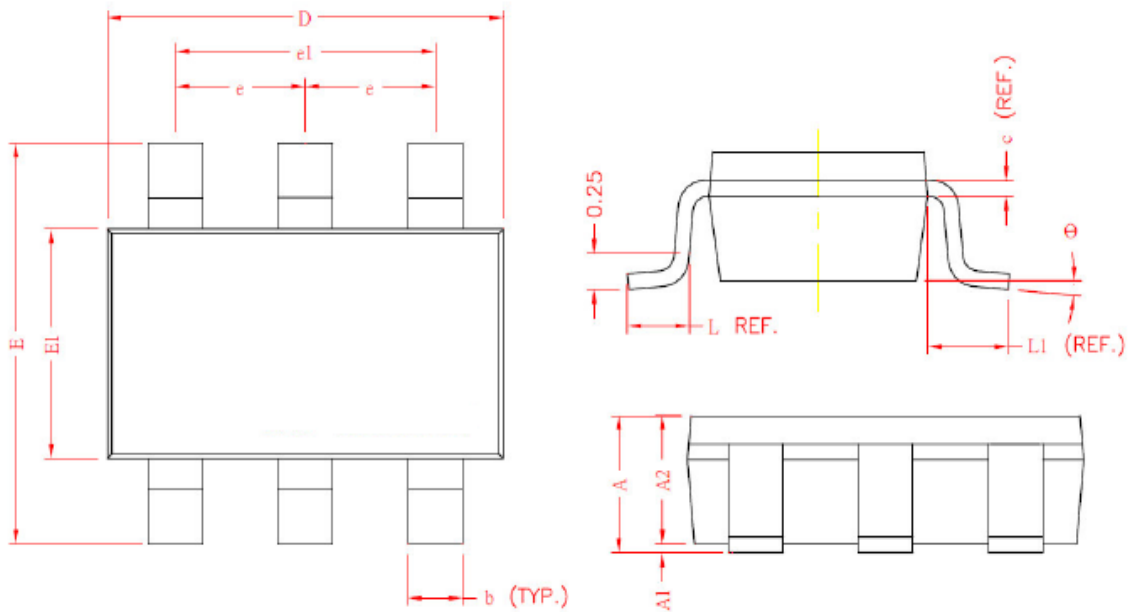

Fig.8 Gate Charge Waveform

Package Dimension

TSOP-6 Plastic Package Information







Dimensions				
Symbol	Millimeters		Inches	
	Min	Max	Min	Max
A	-	1.45	-	0.057
A1	0.00	0.10	0.000	0.004
A2	0.70	1.35	0.028	0.053
c	0.12 (REF)		0.005 (REF)	
D	2.70	3.10	0.106	0.122
E	2.60	3.00	0.102	0.118
E1	1.40	1.80	0.055	0.071
L	0.45 (REF)		0.018 (REF)	
L1	0.60 (REF)		0.024 (REF)	
θ	0°	10°	0°	10°
b	0.30	0.50	0.012	0.020
e	0.95 (REF)		0.037 (REF)	
e1	1.90 (REF)		0.075 (REF)	

NOTICE

Information furnished is believed to be accurate and reliable. However Globaltech Semiconductor assumes no responsibility for the consequences of use of such information nor for any infringement of patents or other rights of third parties, which may result from its use. No license is granted by implication or otherwise under any patent or patent rights of Globaltech Semiconductor. Specifications mentioned in this publication are subject to change without notice. This publication supersedes and replaces all information without express written approval of Globaltech Semiconductor.

CONTACT US

GS Headquarter

	4F.,No.43-1,Lane11,Sec.6,Minquan E.Rd Neihu District Taipei City 114, Taiwan (R.O.C)
	886-2-2657-9980
	886-2-2657-3630
	sales_twn@gs-power.com

RD Division

	824 Bolton Drive Milpitas. CA. 95035
	1-408-457-0587