

GS9122

Precision Load Switch with Adjustable Current Limit

Product Description

The GS9122 is a load switch which provides full protection to systems and loads which may encounter large current conditions. GS9122 offers a 95mΩ current-limited switch which can operate over an input voltage range of 2.5-5.5V. The current limit can be externally programmed by a precision resistor, ranges from 75mA to 1.7A. Switch control is by a logic input (EN) capable of interfacing directly with low voltage control signals. Current is prevented from flowing when the switch is off and the output voltage is higher than the input voltage.

GS9122 also features thermal shutdown protection which shuts off the switch to prevent damage to the part when a continuous over-current condition causes excessive heating. When the switch current reaches the current limit, the parts operate in a constant-current mode to prohibit excessive currents from causing damage. The GS9122 will not turn off after a current limit fault, but will rather remain in the constant current mode indefinitely. The nFAULT output asserts low during over-current and reverse-voltage conditions.

Features

- Up to 1.5A Max Load current
- Accurate Current-limit threshold: +/-5%
- Programmable Current-limit: 75mA to 1.7A
- Fast Over-Current Response
- Fault Flag Output: nFAULT Pin
- Reversed Current blocking
- Thermal Shutdown, UVLO protection
- Tiny SOT-23-6L Package
- RoHS Compliant, 100%Pb & Halogen Free

Applications

- USB ports/Hubs
- Hot Swaps
- Cell phones
- Tablet PC
- Set Top Box
- PC motherboard
- Handheld Devices

Block Diagram

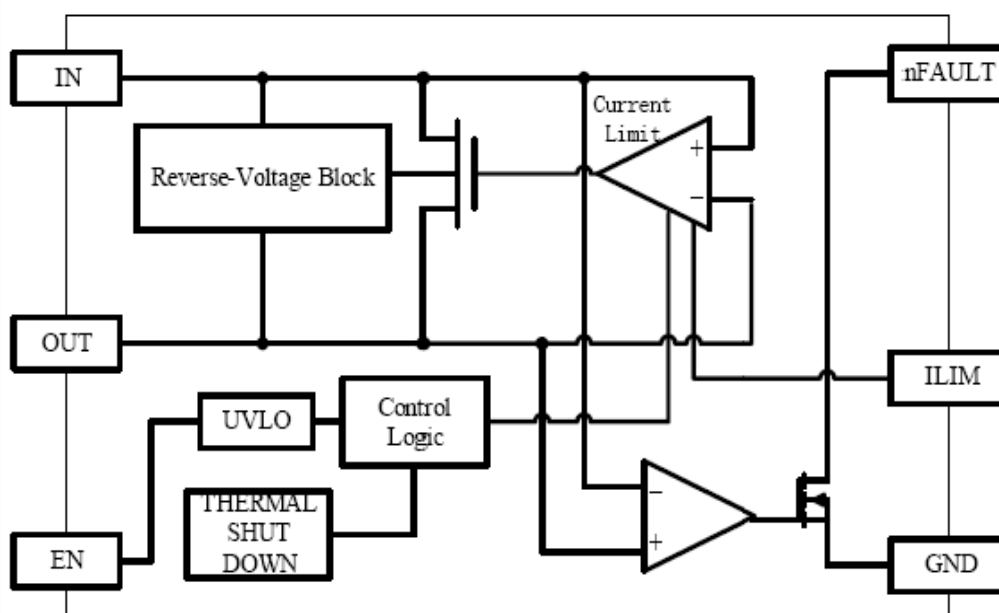

Packages & Pin Assignments

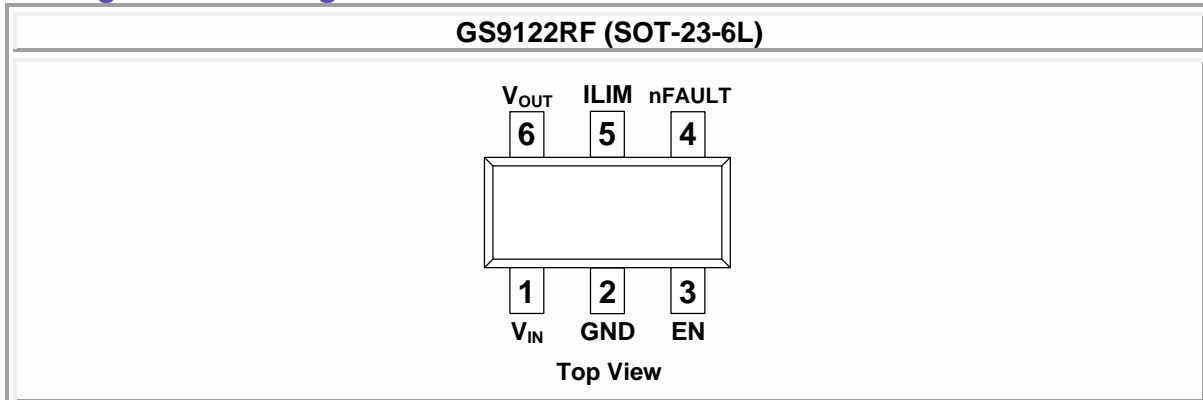

Pin No	Pin Name	Description
1	V _{IN}	Power input. Bypass with a 4.7μF capacitor to GND
2	GND	Ground pin
3	EN	Enable pin
4	nFAULT	Fault flagging pin. Connect a pull up resistor to V _{IN} , when in fault conditions, this pin is asserted low
5	ILIM	Current limit threshold setting pin. Connect a resistor from this pin to GND to set different current limit values
6	V _{OUT}	Current limit Output. Bypass with a capacitor that is greater than 120μF if used for USB

Ordering & Marking Information

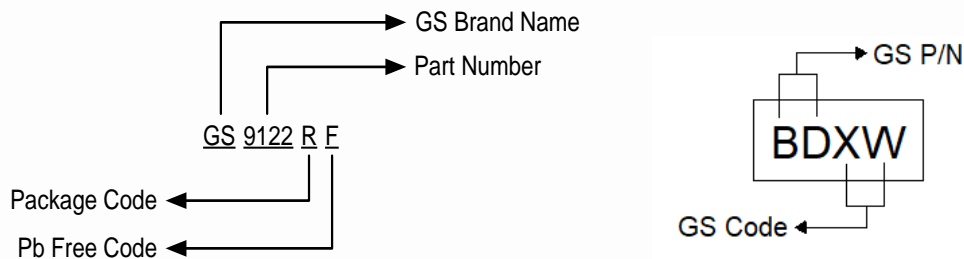

Part Number	Marking ID	Package	Quantity
GS9122RF	BDXW	SOT-23-6L	3000 PCS

Typical Application

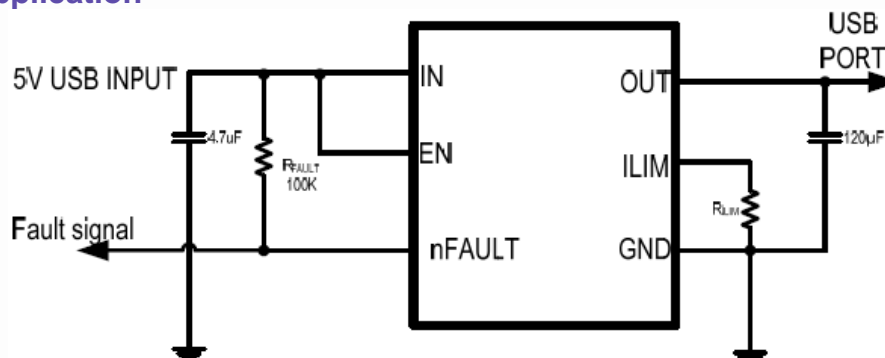

Absolute Maximum Ratings (Note 1)

Symbol	Parameter	Value	Units
V _{IN}	Input Voltage	-0.3 to 6.0	V
V _{EN}	Enable Voltage	-0.3 to V _{IN} +0.3	V
	Output, ILIM, nFAULT to GND	-0.3 to V _{IN} +0.3	V
I _{OUT}	Output to GND Current	Internally limited	-
T _A	Operating Temperature Range	-40 to +85	°C
T _{STG}	Storage Temperature Range	-55 to +150	°C
T _{LEAD}	Lead Temperature(Soldering, 10 sec)	260	°C

Note 1: Stresses greater than those listed under "Absolute Maximum Ratings" may cause permanent damage to the device. These are stress ratings only, and functional operation of the device at these or any other conditions beyond those indicated under "Recommended Operating Conditions" is not implied. Exposure to "Absolute Maximum Ratings" for extended periods may affect device reliability.

Electrical Characteristics

(V_{IN}=5.0V, unless otherwise specified, Typical values are at T_A=25°C.)

Parameter	Test Conditions	Min	Typ	Max	Unit
Input Voltage Range		2.5		5.5	V
Input UVLO	Rising, Hysteresis=25mV		2.35		V
Input Supply Current	R _{ILIM} =20K		120		μA
Input Shutdown Current			0.5	1.5	μA
Power Switch On Resistance	I _{SW} =500mA		95		mΩ
	I _{SW} =500mA, -40°C ≤ T _J ≤ 120°C			145	mΩ
Current limit Threshold	R _{ILIM} =15K		1.705		A
	R _{ILIM} =20K		1.295		A
	R _{ILIM} =49.9K		0.520		A
Response time to Short-circuit			1		μS
Reverse-voltage Threshold	V _{OUT} -V _{IN}		150		mV
Reverse Leakage Current	V _{OUT} =5.5V, V _{IN} =0V, V _{EN} =High		0.5	2	μA
EN Input Logic High threshold	V _{FAULT} =5.5V	1			V
EN Input Logic Low threshold				0.66	V
nFAULT Output Low Voltage	I _{nFAULT}		70	170	mV
nFAULT Output Leakage				1	μA
nFAULT Deglitch Time	De-assertion due to Over-current		9		MS
	De-assertion due to Reverse-Voltage		4.5		
Thermal Shutdown			160		°C
Thermal Shutdown In Current Limit			135		°C
Thermal Shutdown Hysteresis			15		°C

Typical Performance Characteristics

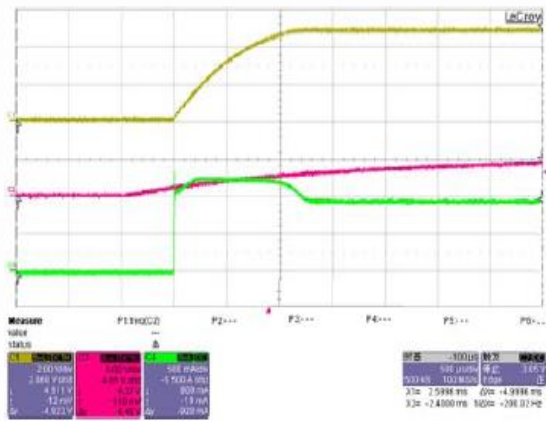

Turn on Delay and Rise time
VIN=5V, RILIM=20K, ROUT=5Ω

CH1: Output Voltage; CH2: Enabled pin Voltage; CH4: Input Current

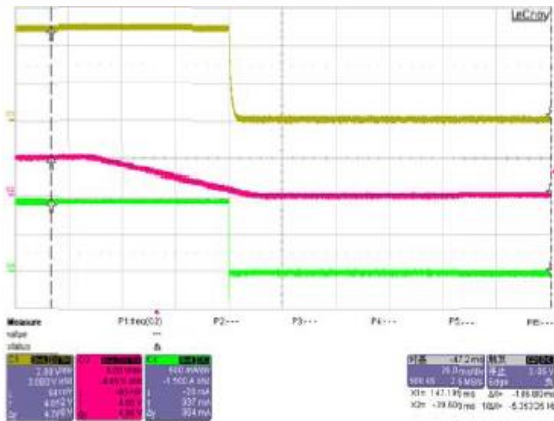

Turn off Delay and Fall Time
VIN=5V, RILIM=20K, ROUT=5Ω

CH1: Output Voltage; CH2: Enabled pin Voltage; CH4: Input Current

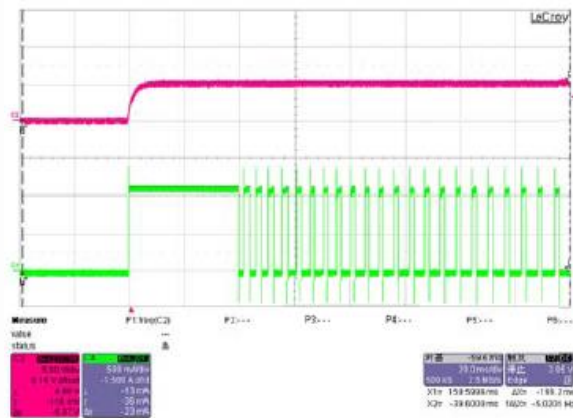

Device Enabled into short-Circuit
VIN=5V, RILIM=20K, ROUT=0Ω
CH2: Enabled pin Voltage; CH4: Input Current

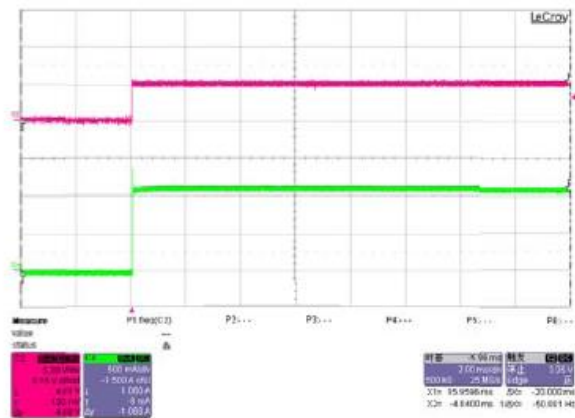

Device Enabled into short-Circuit
VIN=5V, RILIM=20K, ROUT=0Ω
CH2: Enabled pin Voltage; CH4: Input Current

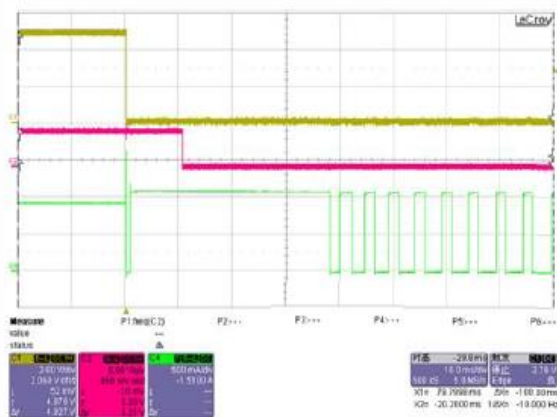

Full Load to Short-Circuit
VIN=5V, RILIM=20K
CH1: Output Voltage; CH2: n Fault pin Voltage; CH4: Input Current

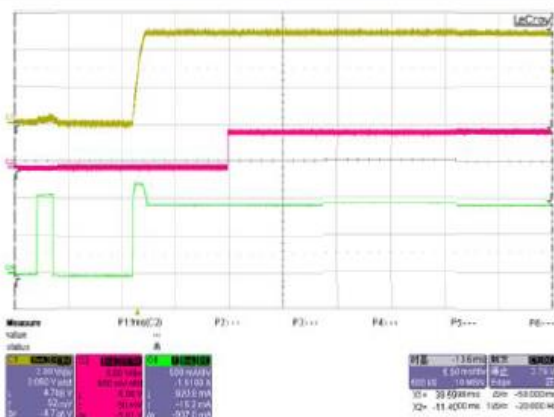

Short-Circuit to Full load
VIN=5V, RILIM=20K
CH1: Output Voltage; CH2: n Fault pin Voltage; CH4: Input Current

Typical Performance Characteristics (Continue)

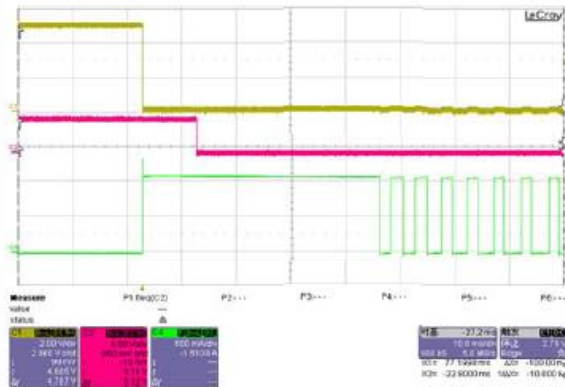

No-load to Short-Circuit
 $V_{IN}=5V, R_{ILIM}=20K$
 CH1: Output Voltage; CH2: n FAULT pin Voltage;
 CH4: Input Current

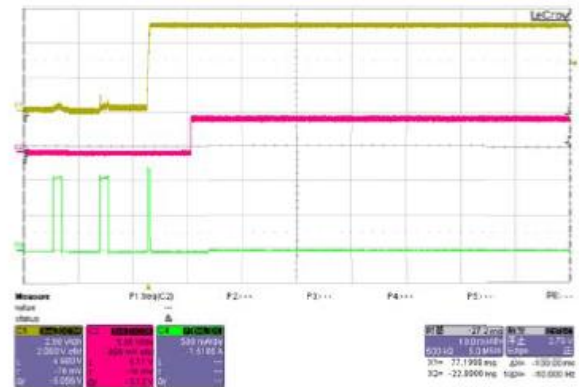

Short-Circuit to No-load $V_{IN}=5V, R_{ILIM}=20K$
 CH1: Output Voltage;
 CH2: n FAULT pin Voltage; CH4: Input Current

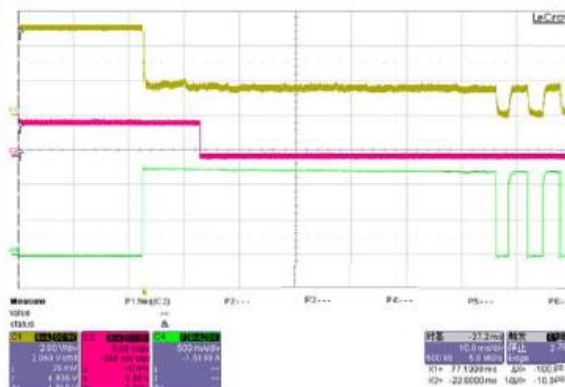

No-load to 1Ω -load
 $V_{IN}=5V, R_{ILIM}=20K$
 CH1: Output Voltage; CH2: n FAULT pin Voltage
 CH4: Input Current

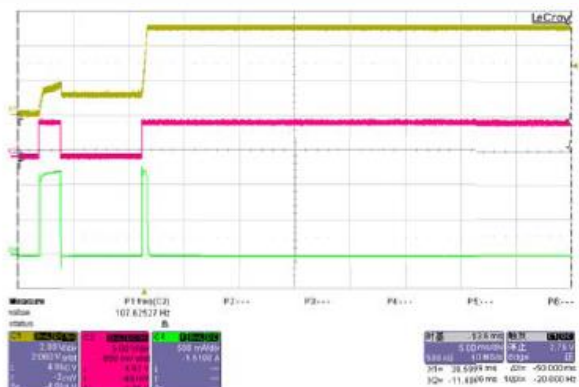

1Ω -load to No-load
 $V_{IN}=5V, R_{ILIM}=20K$
 CH1: Output Voltage; CH2: n FAULT pin Voltage
 CH4: Input Current

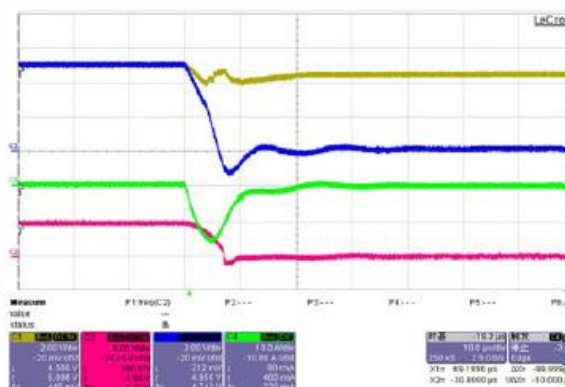

Input Voltage from 5V into 0V
 $V_{OUT}=5V, R_{ILIM}=20K, R_{OUT}=10\Omega$
 CH1: Output Voltage; CH2: n FAULT pin Voltage
 CH3: Input Voltage; CH4: Input Current

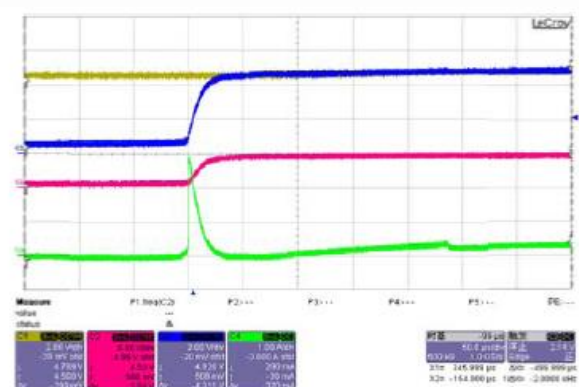

Input Voltage from 0V into 5V
 $V_{OUT}=5V, R_{ILIM}=20K, R_{OUT}=10\Omega$
 CH1: Output Voltage; CH2: n FAULT pin Voltage
 CH3: Input Voltage; CH4: Input Current

Typical Performance Characteristics (Continue)

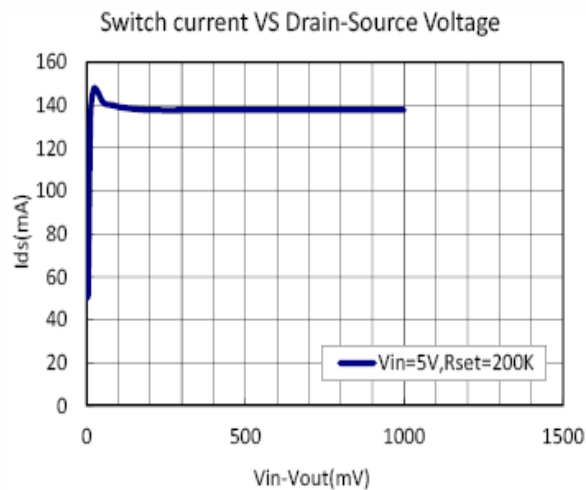
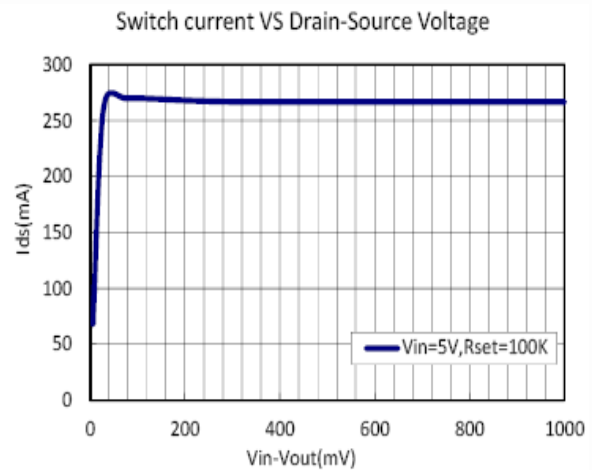
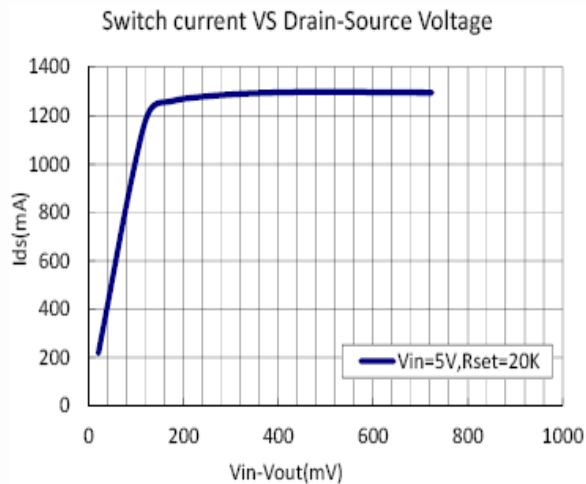

Application Information

Function Description

The GS9122 is a load switch which provides full protection to systems and loads which may encounter large current conditions. GS9122 offers a 95mΩ current-limited switch which can operate over an input voltage range of 2.5-5.5V. The current limit can be externally programmed by a precision resistor, ranges from 75mA to 1.7A. GS9122 also features reverse voltage blocking, UVLO, and thermal shutdown to protect IC from overheating. An nFAULT flag output provides a pull-down signal to indicate fault conditions.

Current Limiting

The current limit ensures that the current through the switch doesn't exceed a maximum value while not limiting at less than a minimum value. The current at which the parts will limit is adjustable through the selection of an external resistor connected to ILIM. Information for selecting the resistor is found in the Application Info section. GS9122 thermal cycles if an overload condition is present long enough to activate thermal limiting in any of the above cases. The device turns off when the junction temperature exceeds 135°C (typ.) while in current limit. The device remains off until the junction temperature cools 10°C (typ.) and then restarts.

Reverse-Voltage Blocking

The reverse-voltage protection feature turns off the Power MOSFET whenever the output voltage exceeds the input voltage by 150mV (typ.) for 4ms (typ.). This prevents damage to devices on the input side of the GS9122 by preventing significant current from sinking into the input capacitance. The GS9122 allow the power MOSFET to turn on once the output voltage goes below the input voltage for the same 4ms deglitch time. The reverse-voltage condition also asserts the nFAULT output (active-low) after 4ms. During "OFF" condition, the reverse-voltage blocking function is still in effect, preventing any current floating from OUT to IN even when the device is not in use.

Application Information (Continue)

nFAULT FLAG

The FAULT open-drain output is asserted (active low) during an over current, over temperature or reverse-voltage condition. The GS9122 asserts the FAULT signal until the fault condition is removed and the device resumes normal operation. The nFAULT signal is de-asserted once device power is cycled or the enable is toggled and the device resumes normal operation. The GS9122 is designed to eliminate false nFAULT reporting by using an internal delay "deglitch" circuit for over current (9ms typ.) and reverse-voltage (4.5ms typ.) conditions without the need for external circuitry. This ensures that nFAULT is not accidentally asserted due to normal operation such as starting into a heavy capacitive load. The deglitching circuitry delays entering and leaving fault conditions. Over temperature conditions are not deglitched and assert the nFAULT signal immediately.

Input Output Capacitance

Input and output capacitance improves the performance of the device; the actual capacitance should be optimized for the particular application. For all applications, a 4.7µF or greater ceramic bypass capacitor between IN and GND is recommended as close to the device as possible for local noise de-coupling. This precaution reduces ringing on the input due to power-supply transients. Additional input capacitance may be needed on the input to reduce voltage overshoot from exceeding the absolute maximum voltage of the device during heavy transient conditions. This is especially important during bench testing when long, inductive cables are used to connect the evaluation board to the bench power-supply. Placing a high-value electrolytic capacitor on the output pin is recommended when large transient currents are expected on the output.

Setting The Current Limit Threshold

R _{ILIM} (KΩ)	Typical Current Limit (mA)
200	138
180	152
151	179
100	266
82	324
68	389
51	520
43	612
30	873
20	1295
15.1	1705

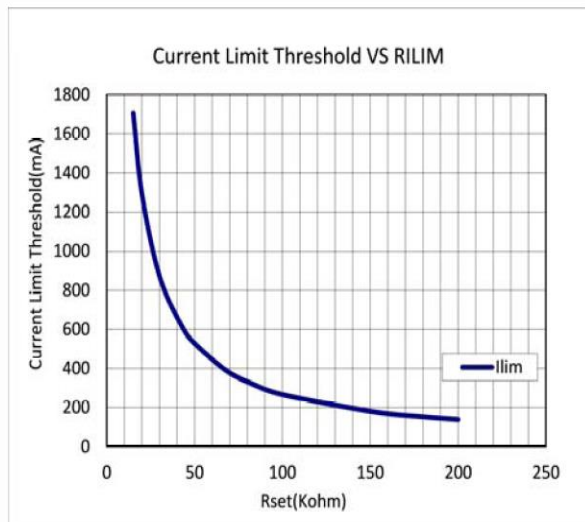

Power Dissipation

During normal operation as a switch, the power dissipated in the part will depend upon the level at which the current limit is set. The maximum allowed setting for the current limit is 1A and this will result in a power dissipation of,

$$P=(I_{LIM})^2 \times R_{DS}=(1)^2 \times 0.10=100\text{mW}$$

If the part goes into current limit the maximum power dissipation will occur when the output is shorted to ground. This is more power than the package can dissipate, but the thermal shutdown of the part will activate to protect the part from damage due to excessive heating. A short on the output will cause the part to operate in a constant current state dissipating a worst case power of, This large amount of power will activate the thermal shutdown and the part will cycle in and out of thermal shutdown so long as the ON pin is active and the short is present.

Package Dimension

SOT-23-6L

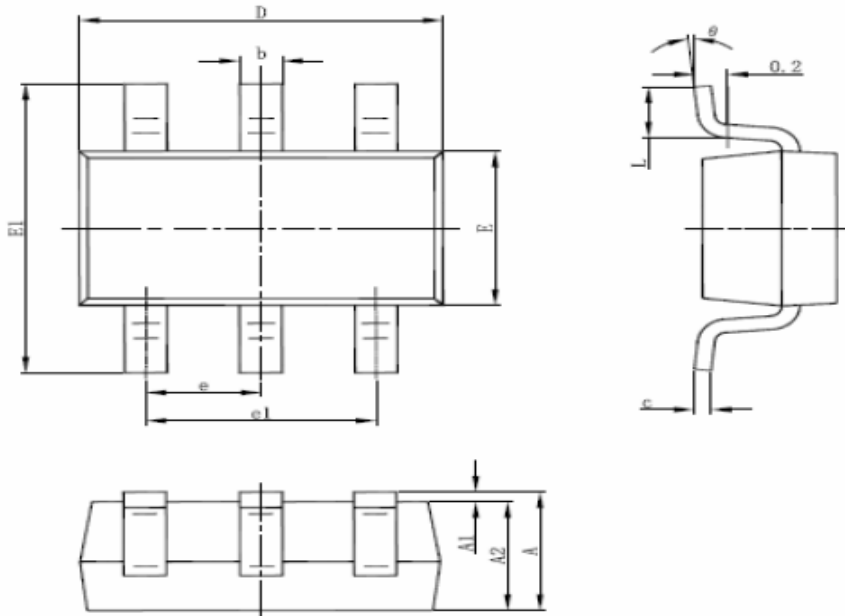







Dimensions				
SYMBOL	Millimeters		Inches	
	MIN	MAX	MIN	MAX
A	-	1.450	-	0.057
A1	0.000	0.150	0.000	0.006
A2	0.900	1.300	0.035	0.052
b	0.300	0.500	0.012	0.020
c	0.100	0.200	0.004	0.008
D	2.800	3.000	0.110	0.118
E	1.500	1.700	0.059	0.067
E1	2.600	3.000	0.102	0.118
e	0.950 (BSC)		0.037 (BSC)	
e1	1.800	2.000	0.071	0.079
L	0.300	0.600	0.012	0.024
θ	0°	8°	0°	8°

NOTICE

Information furnished is believed to be accurate and reliable. However Globaltech Semiconductor assumes no responsibility for the consequences of use of such information nor for any infringement of patents or other rights of third parties, which may result from its use. No license is granted by implication or otherwise under any patent or patent rights of Globaltech Semiconductor. Specifications mentioned in this publication are subject to change without notice. This publication supersedes and replaces all information without express written approval of Globaltech Semiconductor.

CONTACT US

GS Headquarter	
	4F.,No.43-1,Lane11,Sec.6,Minquan E.Rd Neihu District Taipei City 114, Taiwan (R.O.C)
	886-2-2657-9980
	886-2-2657-3630
	sales_twn@gs-power.com

RD Division	
	824 Bolton Drive Milpitas. CA. 95035
	1-408-457-0587