

GS5453A

17V, 3A, 800KHz ECOT Force-CCM Sync, Step-Down Converter

Product Description

The GS5453A is a high frequency, synchronous, rectified, step-down, switch-mode converter with internal power MOSFETs. It offers a very compact solution to provide a 3A continuous output current over a wide input supply range, with excellent load and line regulation. ECOT control operation provides very fast transient response and easy loop design as well as very tight output regulation.

The GS5453A requires a minimal number of readily available, external components and is available in a space saving SOT-563 package.

Features

- Wide 4.5V to 17V Operating Input Range
- 63mΩ/36mΩ Low- $R_{DS(ON)}$ Internal Power MOSFETs
- ECOT Mode Control with Fast Transient Response
- Shutdown Current 4μA Maximum
- 800kHz Switching Frequency
- Input Over Voltage Protection
- Over Current Limit
- Short Protection with Hiccup-Mode
- Continuous Conduction Mode (CCM)
- Output Adjustable from 0.805V
- Integrated internal compensation
- Output current up to 3A
- Internal Soft-Start
- SOT-563 Package
- RoHS Compliant & Halogen Free

Applications

- Wireless AP/Router
- Display and Notebook Computers
- Flat-Panel Television and Monitor
- Networking System PGA, DSP, ASIC Power
- Portable Media Player
- Set Top Boxes
- xDSL Modem

Functional Block Diagram

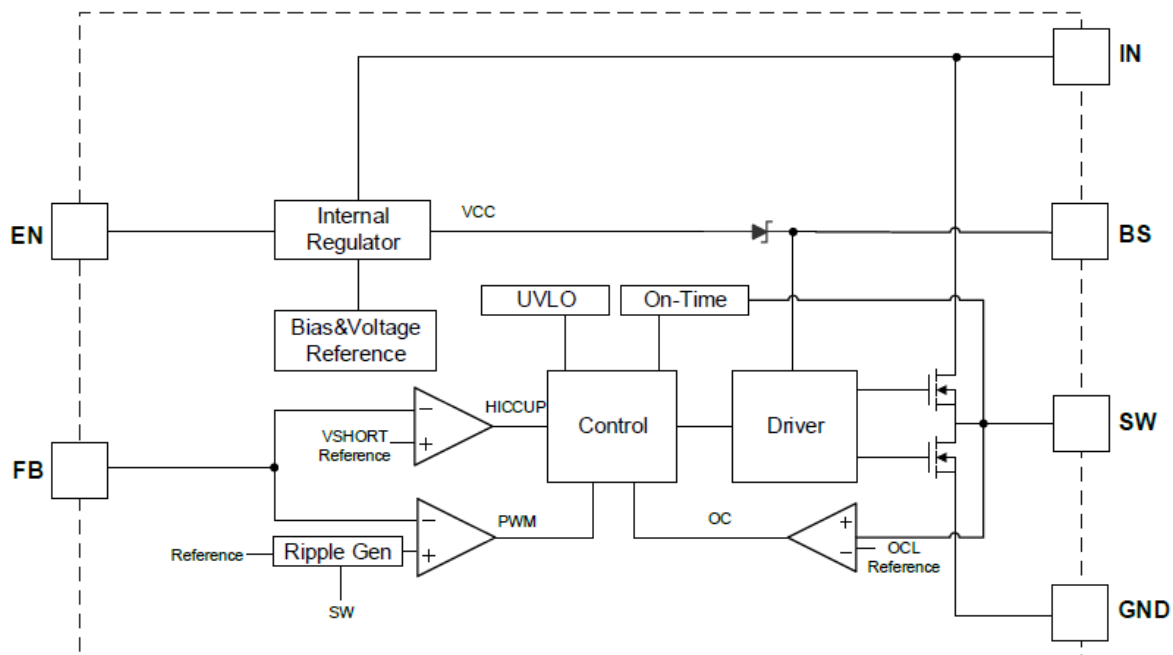

Packages & Pin Assignments

GS5453AX7F (SOT-563)		
<p>(Top View)</p>		
Pin	Name	Description
1	IN	Supply Voltage. The GS5453A Operates from a 4.5V to 17V input rail.
2	SW	Switch Output. Connect using wide a PCB trace.
3	GND	System Ground.
4	BS	Bootstrap. A capacitor connected between SW and BS pins is required to form a floating supply across the high-side switch driver.
5	EN	Drive this pin to a logic-high to enable the IC. Drive to a logic-low to disable the IC and enter micro-power shutdown mode.
6	FB	Adjustable Version Feedback input. Connect FB to the center point of the external resistor divider.

Ordering & Marking Information

Part Number	Package	Part Marking	Quantity / Reel
GS5453AX7F	SOT-563	EP□□□	5,000 PCS

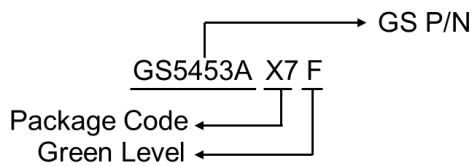

- Package Code
X7 : SOT-563
- Green Level
F : RoHS and Halogen Free

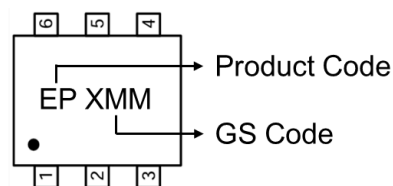

Absolute Maximum Rating (Note 1,2)

Symbol	Parameter	Value	Unit
V _{IN} , V _{EN}	Input Voltage	-0.3 to 19	V
V _{SW}	Switch Pin Voltage	-0.3 to (V _{IN} +1)	V
V _{BS}	Boost Pin Voltage	-0.3 to (V _{SW} +5)	V
V _{FB}	Feedback Pin Voltage	-0.3 to 6	V
T _J	Operating Junction Temperature	-40 to +150	°C
T _{STG}	Storage temperature Range	-55 to +150	°C
V _(ESD-HBM)	Human Body Mode (HBM) ANSI/ESDA/JEDEC JS-001-2014 Classification, Class : 2	±2000	V
V _(ESD-CDM)	Charged Device Mode (CDM) ANSI/ESDA/JEDEC JS-002-2014 Classification, Class : C0b	±200	V
I _{LATCH-UP}	JEDEC STANDARD NO.78E APRIL 2016 Temperature Classification, Class : I	±150	mA
R _{θJA}	Thermal Resistance Junction to Ambient	155	°C/W
P _D	Power Dissipation (Note 3)	Internally Limited	W

Note:

- Exceeding these ratings may damage the device.
- The device is not guaranteed to function outside of its operating conditions.
- The maximum allowable power dissipation is a function of the maximum junction temperature, T_{J(MAX)}, the junction-to-ambient thermal resistance, R_{θJA}, and the ambient temperature, T_A. The maximum allowable power dissipation at any ambient temperature is calculated using: P_{D (MAX)} = (T_{J(MAX)} - T_A)/R_{θJA}. Exceeding the maximum allowable power dissipation causes excessive die temperature, and the regulator goes into thermal shutdown. Internal thermal shutdown circuitry protects the device from permanent damage. Thermal shutdown engages at T_J=160°C (typical) and disengages at T_J= 130°C (typical).

Recommended Operating Conditions

Symbol	Min.	Max.	Unit
Operating junction temperature (Note4)	-40	125	°C
Operating temperature range	-40	85	°C
Input voltage, V _{IN}	4.5	17	V
Output current	0	3	A

Note:

- All limits specified at room temperature (T_A = 25°C) unless otherwise specified. All room temperature limits are 100% production tested. All limits at temperature extremes are ensured through correlation using standard Statistical Quality Control (SQC) methods. All limits are used to calculate Average Outgoing Quality Level (AOQL).

Electrical Characteristics (Note 5,6)
 (Typical values $V_{IN}=12V$, $T_A=25^{\circ}C$, unless otherwise specified)

Symbol	Parameter	Test Conditions	Min.	Typ.	Max.	Units
V_{IN}	Input Voltage	-	4.5	-	17	V
I_Q	Quiescent Current	$V_{EN}=3V$	-	0.6	0.8	mA
I_{SHDN}	Shutdown Supply Current	$V_{EN}=0V$ or GND	-	-	4	μA
V_{FB}	Feedback Voltage	-	0.784	0.805	0.825	V
$R_{DS(ON)H}$	High-Side MOSFET $R_{DS(ON)}$	$I_{SW}=100mA$	-	63	-	m Ω
$R_{DS(ON)L}$	Low-Side MOSFET $R_{DS(ON)}$	$I_{SW}=-100mA$	-	36	-	m Ω
I_{LIMIT}	Valley Switch Current Limit	-	2.8	3	3.2	A
F_{SW}	Switching Frequency	-	-	800	-	KHz
D_{MAX}	Maximum Duty Cycle	$V_{FB}=90\%$	-	94	-	%
V_{ENH}	Enable Rising Threshold	-	1.4	-	-	V
V_{ENL}	Enable Falling Threshold	-	-	-	0.8	V
$UVLO$	Under-Voltage Lockout Threshold	Wake up V_{IN} voltage	-	4.3	4.5	V
		Shutdown V_{IN} voltage	3.6	3.8	-	V
		Hysteresis V_{IN} voltage	-	500	-	mV
OVP	Over Voltage Protection	-	-	19	-	V
$T_{OFF(MAX)}$	Minimum Off-Time	-	-	89	-	ns
T_{SS}	Soft-Start	-	-	1.5	-	ms
T_{SD}	Thermal Shutdown	-	-	160	-	$^{\circ}C$
T_{Hys}	Thermal Hysteresis	-	-	30	-	$^{\circ}C$

Note:

- MOSFET on-resistance specifications are guaranteed by correlation to wafer level measurements.
- Thermal shutdown specifications are guaranteed by correlation to the design and characteristics analysis.

Typical Application Circuit

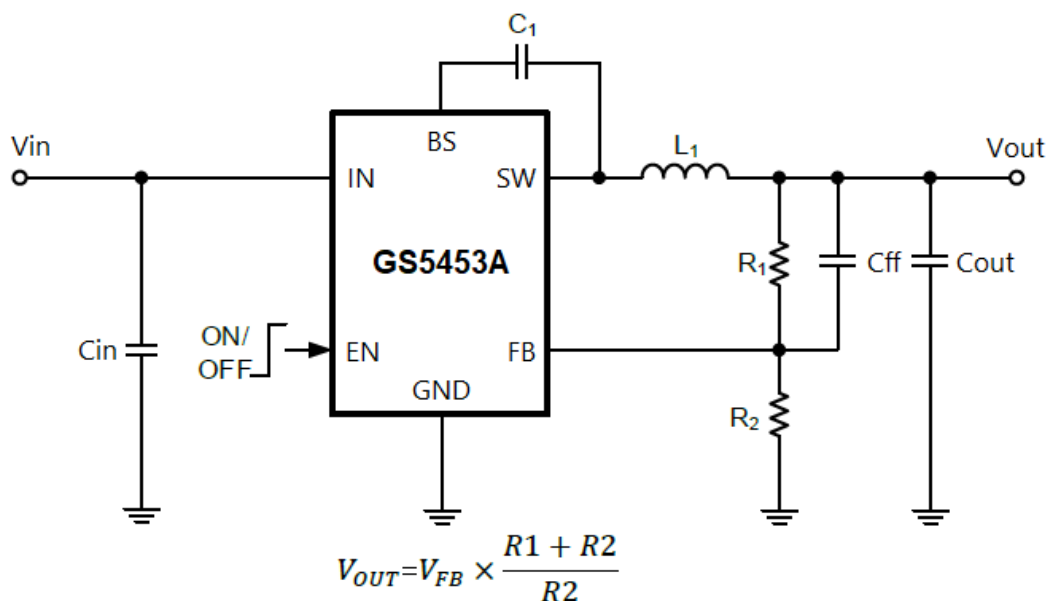

Typical Characteristics (Note7,8)

Efficiency vs. Load Current

$V_{IN}=12V, V_{OUT}=5V/3.3V/1.2V$

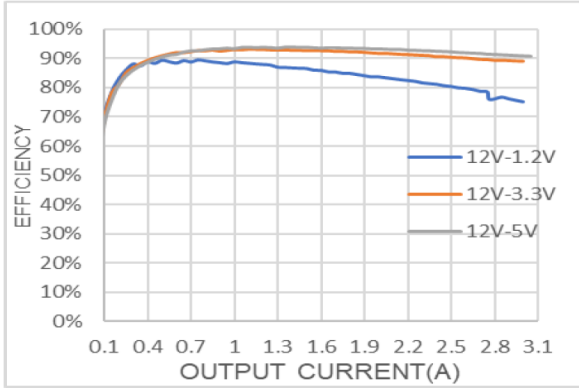

Load Regulation

$V_{IN}=12V, V_{OUT}=5V/3.3V/1.2V$

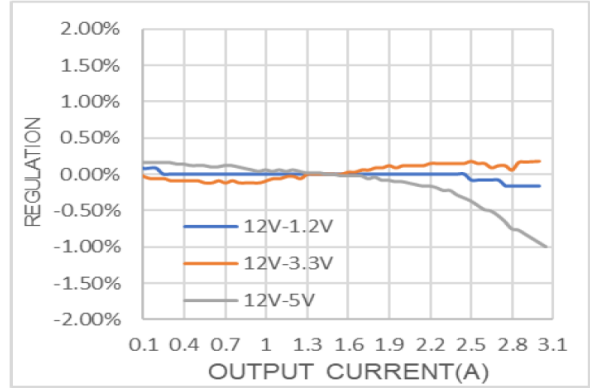

Line Regulation

$V_{IN}=3.3V, I_{OUT}=0A/1.5A/3A$

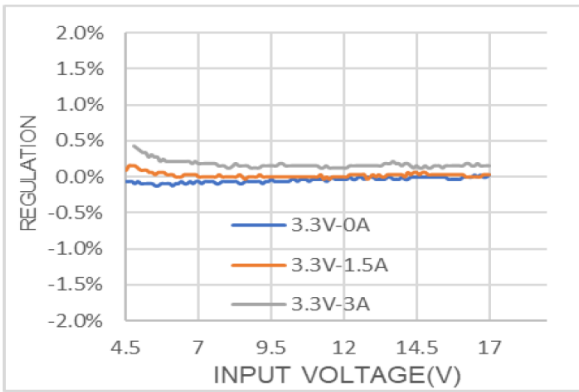

Output Ripple Voltage

$V_{IN}=12V, V_{OUT}=3.3V, I_{OUT}=0A$

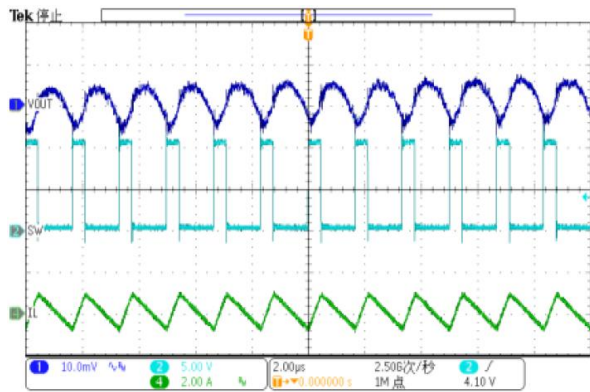

Output Ripple Voltage

$V_{IN}=12V, V_{OUT}=3.3V, I_{OUT}=1.5A$

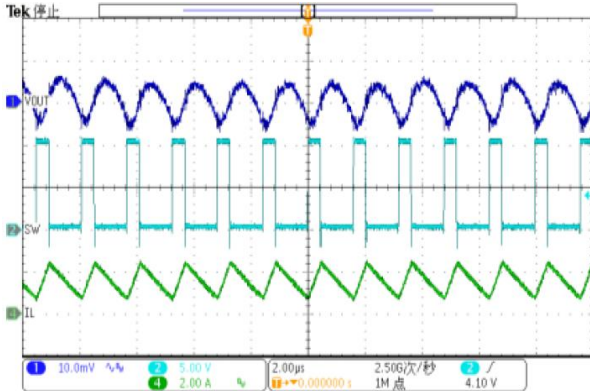

Output Ripple Voltage

$V_{IN}=12V, V_{OUT}=3.3V, I_{OUT}=3A$

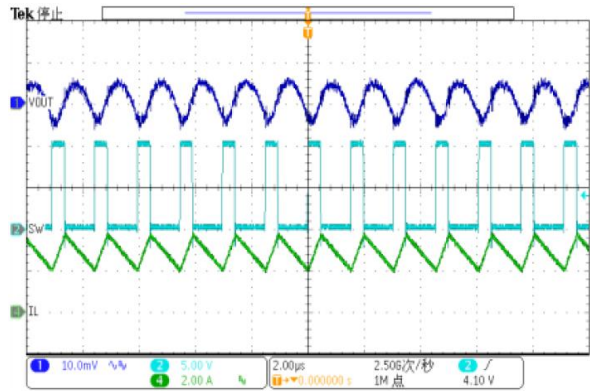

Typical Characteristics

Loop Response

$V_{IN}=12V, V_{OUT}=3.3V, I_{OUT}=1.5A-3A$

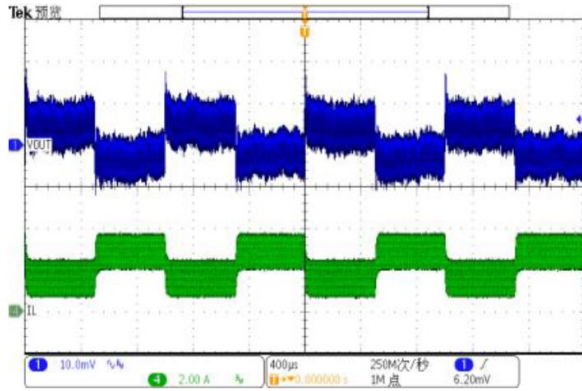

Output Short

$V_{IN}=12V, V_{OUT}=3.3V$

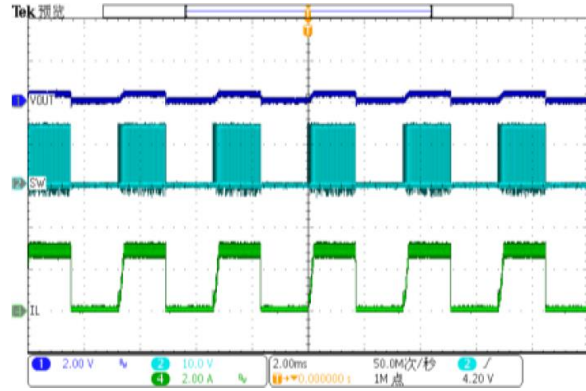

Short Circuit Entry

$V_{IN}=12V, V_{OUT}=3.3V$

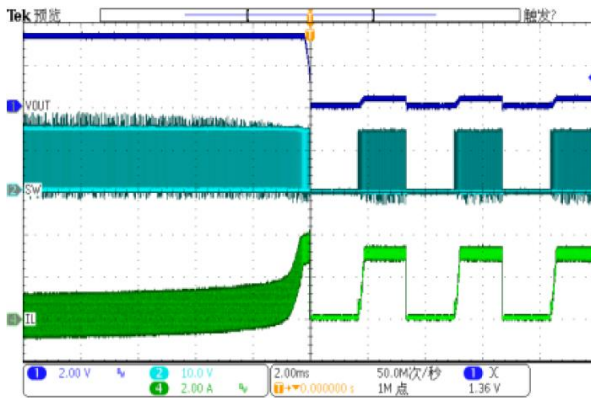

Short Circuit Entry

$V_{IN}=12V, V_{OUT}=3.3V$

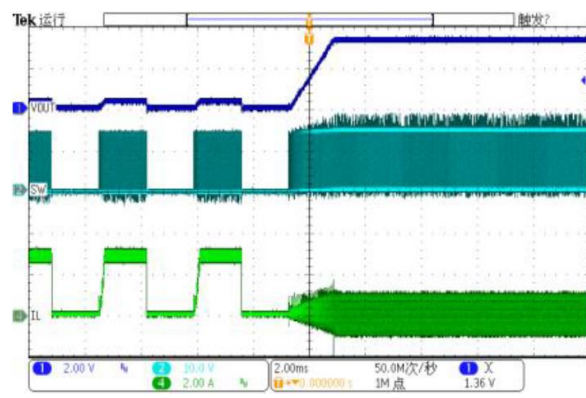

Enable Startup at No Load

$V_{IN}=12V, V_{OUT}=3.3V, I_{OUT}=0A$

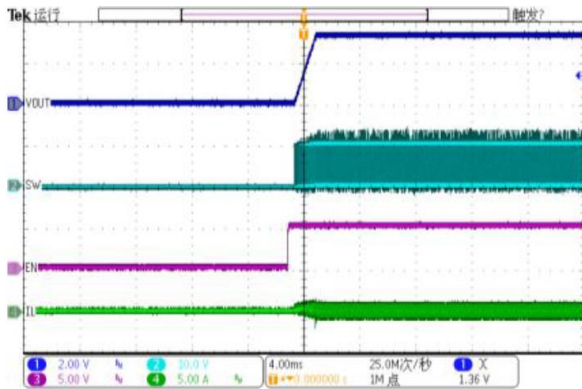

Enable Shutdown at No Load

$V_{IN}=12V, V_{OUT}=3.3V, I_{OUT}=0A$

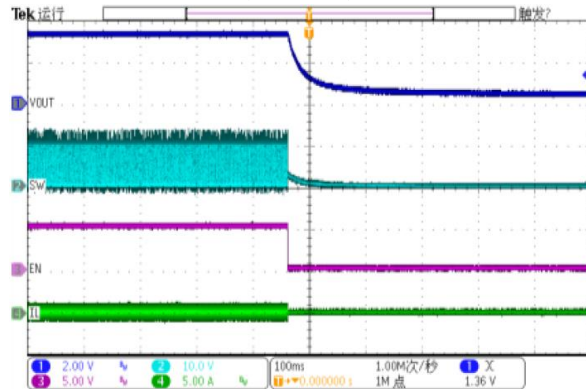

Typical Characteristics

Enable startup at Full Load

$V_{IN}=12V$, $V_{OUT}=3.3V$, $I_{OUT}=0A$

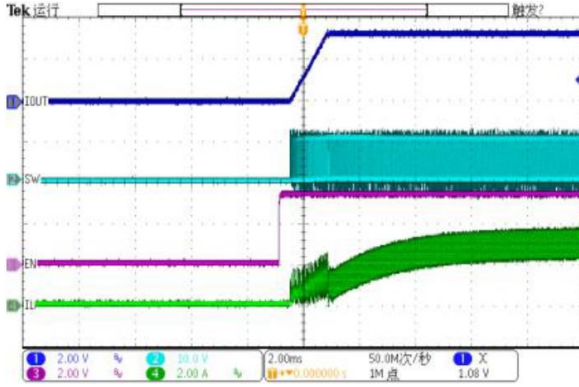

Enable Shutdown at Full Load

$V_{IN}=12V$, $V_{OUT}=3.3V$, $I_{OUT}=3A$

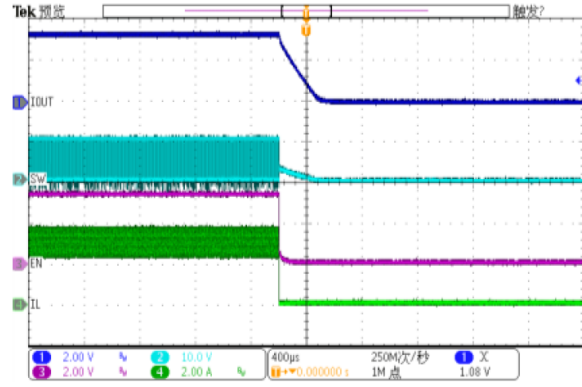

Power Up at No Load

$V_{IN}=12V$, $V_{OUT}=3.3V$, $I_{OUT}=0A$

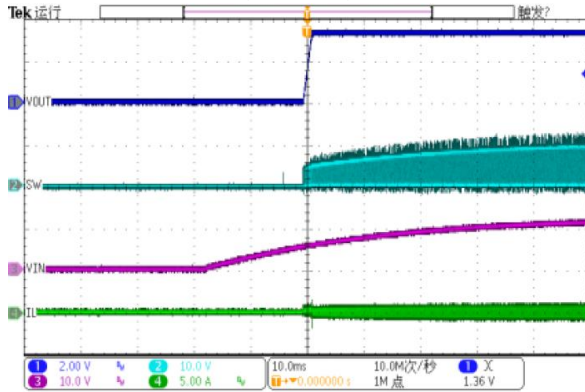

Power Up at Full Load

$V_{IN}=12V$, $V_{OUT}=3.3V$, $I_{OUT}=3A$

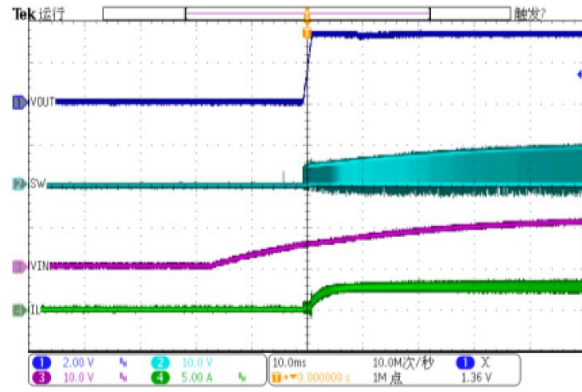

Note:

7. Performance waveforms are tested on the evaluation board.
8. $V_{IN}=12V$, $V_{OUT}=3.3V$, $T_A = +25^{\circ}C$, unless otherwise noted.

Function Description

Internal Regulator

The GS5453A is a ECOT mode step down DC/DC converter that provides excellent transient response with no extra external compensation components. This device contains an internal, low resistance, high voltage power MOSFET, and operates at a high 800KHz operating frequency to ensure a compact, high efficiency design with excellent AC and DC performance.

Under-Voltage Lockout (UVLO)

Under-voltage lockout (UVLO) protects the chip from operating at an insufficient supply voltage. UVLO protection monitors the internal regulator voltage. When the voltage is lower than UVLO threshold voltage, the device is shut off. When the voltage is higher than UVLO threshold voltage, the device is enabled again.

Thermal Shutdown

Thermal shutdown prevents the chip from operating at exceedingly high temperatures. When the silicon die temperature exceeds 160°C, it shuts down the whole chip. When the temperature falls below its lower threshold (Typ. 130°C) the chip is enabled again.

Internal Soft-Start

The soft-start is implemented to prevent the converter output voltage from overshooting during startup. When the chip starts, the internal circuitry generates a soft-start voltage (SS) ramping up from 0V to 0.805V. When it is lower than the internal reference (REF), SS overrides REF so the error amplifier uses SS as the reference. When SS is higher than REF, REF regains control. The SS time is internally max to 1.5ms.

Over Current Protection and Hiccup

The GS5453A has cycle-by-cycle over current limit when the inductor current valley value exceeds the set current limit threshold. Meanwhile, output voltage starts to drop until FB is below the Under-Voltage (UV) threshold. Once a UV is triggered, the GS5453A enters hiccup mode to periodically restart the part. This protection mode is especially useful when the output is dead-short to ground. The average short circuit current is greatly reduced to alleviate the thermal issue and to protect the regulator. The GS5453A exits the hiccup mode once the over current condition is removed.

Startup and Shutdown

If both V_{IN} and EN are higher than their appropriate thresholds, the chip starts. The reference block starts first, generating stable reference voltage and currents, and then the internal regulator is enabled. The regulator provides stable supply for the remaining circuitries. Three events can shut down the chip: EN low, V_{IN} low and thermal shutdown. In the shutdown procedure, the signaling path is first blocked to avoid any fault triggering. The comp voltage and the internal supply rail are then pulled down. The floating driver is not subject to this shutdown command.

Applications Information

Setting the Output Voltage

GS5453A require an input capacitor, an output capacitor and an inductor. These components are critical to the performance of the device. GS5453A are internally compensated and do not require external components to achieve stable operation. The output voltage can be programmed by resistor divider.

$$V_{OUT} = V_{FB} \times \frac{R1 + R2}{R2}$$

V _{out} (V)	R1(KΩ)	R2(KΩ)	L1(μH)	C1(nF)	C _{in} (μF)	C _{out} (μF)	C _{FF} (pF) Opt.
1.0	2.42	10	1.5	100	22	22x2	C _{FF} Chapter
1.05	3.04	10	1.5	100	22	22x2	C _{FF} Chapter
1.2	4.91	10	1.5	100	22	22x2	C _{FF} Chapter
1.5	8.63	10	2.2	100	22	22x2	C _{FF} Chapter
1.8	12.36	10	2.2	100	22	22x2	C _{FF} Chapter
2.5	21.06	10	2.2	100	22	22x2	C _{FF} Chapter
3.3	30.99	10	2.2	100	22	22x2	C _{FF} Chapter
5.0	52.11	10	4.7	100	22	22x2	C _{FF} Chapter

All the external components are the suggested values, the final values are based on the application testing results.

Selecting the Inductor

The recommended inductor values are shown in the Application Diagram. It is important to guarantee the inductor core does not saturate during any foreseeable operational situation. The inductor should be rated to handle the maximum inductor peak current: Care should be taken when reviewing the different saturation current ratings that are specified by different manufacturers. Saturation current ratings are typically specified at 25°C, so ratings at maximum ambient temperature of the application should be requested from the manufacturer. The inductor value can be calculated with:

$$L = \frac{V_{OUT} \times (V_{IN} - V_{OUT})}{V_{IN} \times \Delta I_L \times F_{OSC}}$$

Where ΔI_L is the inductor ripple current. Choose inductor ripple current to be approximately 30% to 40% of the maximum load current. The maximum inductor peak current can be estimated as:

$$I_{L(MAX)} = I_{LOAD} + \frac{\Delta I_L}{2}$$

Under light load conditions below 100mA, larger inductance is recommended for improved efficiency. Larger inductances lead to smaller ripple currents and voltages, but they also have larger physical dimensions, lower saturation currents and higher linear impedance. Therefore, the choice of inductance should be compromised according to the specific application.

Selecting the Input Capacitor

The input current to the step-down converter is discontinuous and therefore requires a capacitor to supply AC current to the step-down converter while maintaining the DC input voltage. For a better performance, use ceramic capacitors placed as close to V_{IN} as possible and a 0.1 μ F input capacitor to filter out high frequency interference is recommended. Capacitors with X5R and X7R ceramic dielectrics are recommended because they are stable with temperature fluctuations.

The capacitors must also have a ripple current rating greater than the maximum input ripple current of the converter. The input ripple current can be estimated with Equation:

$$I_{CIN} = I_{OUT} \times \sqrt{\frac{V_{OUT}}{V_{IN}} \times \left(1 - \frac{V_{OUT}}{V_{IN}}\right)}$$

From the above equation, it can be concluded that the input ripple current reaches its maximum at $V_{IN}=2V_{OUT}$ where $I_{CIN} = \frac{I_{OUT}}{2}$. For simplification, choose an input capacitor with an RMS current rating greater than half of the maximum load current.

The input capacitance value determines the input voltage ripple of the converter. If there is an input voltage ripple requirement in the system, choose the input capacitor that meets the specification. The input voltage ripple can be estimate with Equation:

$$\Delta V_{IN} = \frac{I_{OUT}}{F_{OSC} \times C_{IN}} \times \frac{V_{OUT}}{V_{IN}} \times \left(1 - \frac{V_{OUT}}{V_{IN}}\right)$$

Similarly, when $V_{IN}=2V_{OUT}$, input voltage ripple reaches its maximum of $\Delta V_{IN} = \frac{1}{4} \times \frac{I_{OUT}}{F_{OSC} \times C_{IN}}$.

Selecting the Output Capacitor

An output capacitor is required to maintain the DC output voltage. The output voltage ripple can be estimated with Equation:

$$\Delta V_{OUT} = \frac{V_{OUT}}{F_{OSC} \times L} \times \left(1 - \frac{V_{OUT}}{V_{IN}}\right) \times \left(R_{ESR} + \frac{1}{8 \times F_{OSC} \times C_{OUT}}\right)$$

There are some differences between different types of capacitors. In the case of ceramic capacitors, the impedance at the switching frequency is dominated by the capacitance. The output voltage ripple is mainly caused by the capacitance. For simplification, the output voltage ripple can be estimated with Equation:

$$\Delta V_{OUT} = \frac{V_{OUT}}{8 \times F_{OSC}^2 \times L \times C_{OUT}} \times \left(1 - \frac{V_{OUT}}{V_{IN}}\right)$$

A larger output capacitor can achieve a better load transient response, but the maximum output capacitor limitation should also be considered in the design application. If the output capacitor value is too high, the output voltage will not be able to reach the design value during the soft-start time and will fail to regulate. The maximum output capacitor value (C_{OUT_MAX}) can be limited approximately with Equation:

$$C_{OUT_MAX} = (I_{LIM_AVG} - I_{OUT}) \times T_{SS} / V_{OUT}$$

Where I_{LIM_AVG} is the average start-up current during the soft-start period, and T_{SS} is the soft-start time. On the other hand, special attention should be paid when selecting these components. The DC bias of these capacitors can result in a capacitance value that falls below the minimum value given in the recommended capacitor specifications table.

The ceramic capacitor's actual capacitance can vary with temperature. The capacitor type X7R, which operates over a temperature range of -55°C to $+125^{\circ}\text{C}$, will only vary the capacitance to within $\pm 15\%$. The capacitor type X5R has a similar tolerance over a reduced temperature range of -55°C to $+85^{\circ}\text{C}$. Many large value ceramic capacitors, larger than $1\mu\text{F}$ are manufactured with Z5U or Y5V temperature characteristics. Their capacitance can drop by more than 50% as the temperature varies from 25°C to 85°C . Therefore, X5R or X7R is recommended over Z5U and Y5V in applications where the ambient temperature will change significantly above or below 25°C .

Feed-Forward Capacitor (C_{FF})

GS5453A has internal loop compensation, so adding C_{FF} is optional. Specifically, for specific applications, if necessary, consider whether to add feed-forward capacitors according to the situation.

The use of a feed-forward capacitor (C_{FF}) in the feedback network is to improve the transient response or higher phase margin. For optimizing the feed-forward capacitor, knowing the cross frequency is the first thing. The cross frequency (or the converter bandwidth) can be determined by using a network analyzer. When getting the cross frequency with no feed-forward capacitor identified, the value of feed-forward capacitor (C_{FF}) can be calculated with the following equation:

$$C_{FF} = \frac{1}{2\pi \times F_{CROSS}} \times \sqrt{\frac{1}{R1} \times \left(\frac{1}{R1} + \frac{1}{R2}\right)}$$

Where F_{CROSS} is the cross frequency.

To reduce transient ripple, the feed-forward capacitor value can be increased to push the cross frequency to higher region. Although this can improve transient response, it also decreases phase margin and cause more ringing. In the other hand, if more phase margin is desired, the feed-forward capacitor value can be decreased to push the cross frequency to lower region.

PCB Layout Consideration

1. PCB layout is very important to achieve stable operation. It is highly recommended to duplicate EVB layout for optimum performance. If change is necessary, please follow these guidelines for reference.
2. Keep the path of switching current short and minimize the loop area formed by Input capacitor, high-side MOSFET and low-side MOSFET.
3. Bypass ceramic capacitors are suggested to be put close to the VIN Pin.
4. Ensure all feedback connections are short and direct. Place the feedback resistors and compensation components as close to the chip as possible.
5. VOUT, SW away from sensitive analog areas such as FB.
6. Connect IN, SW, and especially GND respectively to a large copper area to cool the chip to improve thermal performance and long-term reliability.

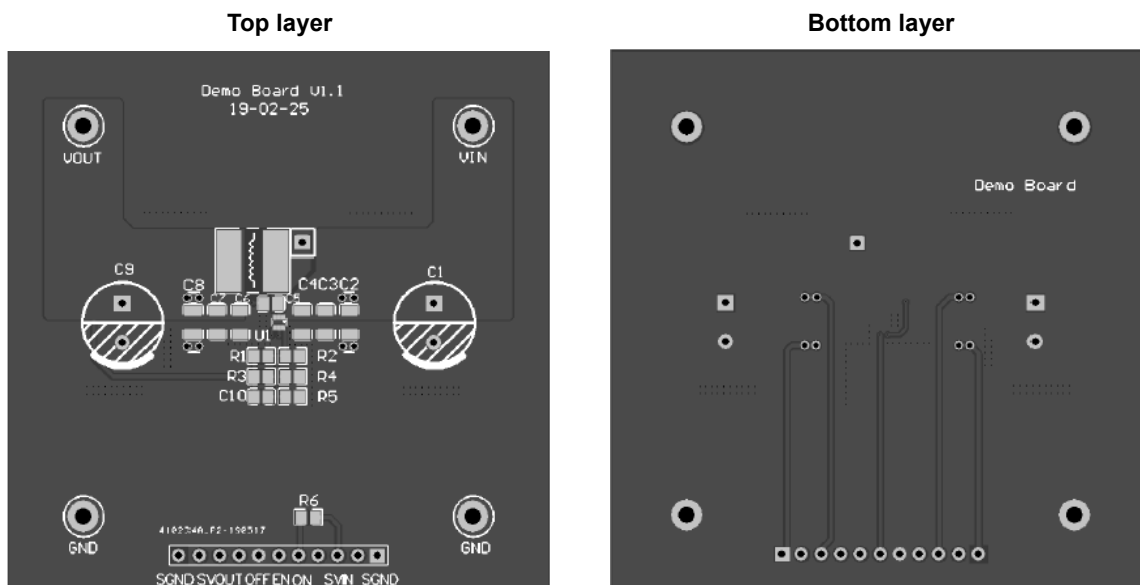

Sample Board Layout

SOT-563

Package Dimension

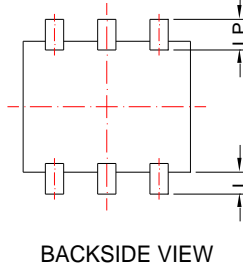
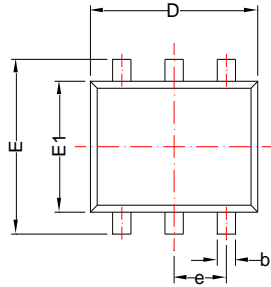

Recommended Land Pattern

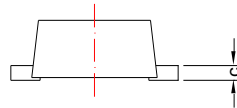
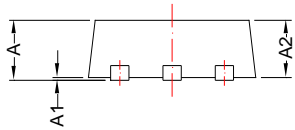
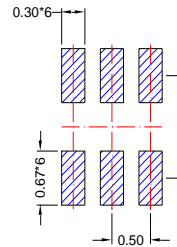

Dimensions

Symbol	Millimeters		Inches	
	Min	Max	Min	Max
A	0.45	0.65	0.018	0.026
A1	0.00	0.10	0.000	0.004
A2	0.45	0.60	0.018	0.024
b	0.15	0.30	0.006	0.012
c	0.07	0.20	0.003	0.008
D	1.50	1.70	0.059	0.067
E	1.50	1.70	0.059	0.067
E1	1.10	1.30	0.043	0.051
e	0.50 BSC		0.020 BSC	
L	0.10	0.30	0.004	0.012
LP	0.16	0.40	0.006	0.016





NOTE :



Dimensions are exclusive of Burrs, Mold Flash & Tie Bar extrusions.

NOTICE

- Globaltech Semiconductor assumes no responsibility for equipment failures that result from using products at values that exceed, even momentarily, rated values (such as maximum ratings, operating condition ranges, or other parameters) listed in products specifications of any and all Globaltech Semiconductor products described or contained herein. Globaltech Semiconductor products are not designed for use in life support appliances, devices or systems where malfunction of these products can be reasonably expected to result in personal injury. Reproduction in whole or in part is prohibited without the prior written consent of the copyright owner.
- Applications shown on the herein document are examples of standard use and operation. Customers are responsible in comprehending the suitable use in particular applications. Globaltech Semiconductor makes no representation or warranty that such applications will be suitable for the specified use without further testing or modification.
- Information furnished is believed to be accurate and reliable. However Globaltech Semiconductor assumes no responsibility for the consequences of use of such information nor for any infringement of patents or other rights of third parties, which may result from its use. No license is granted by implication or otherwise under any patent or patent rights of Globaltech Semiconductor. Specifications mentioned in this publication are subject to change without notice. This publication supersedes and replaces all information without express written approval of Globaltech Semiconductor.

CONTACT US

GS Headquarter	
	4F.,No.43-1,Lane11,Sec.6,Minquan E.Rd Neihu District Taipei City 114, Taiwan (R.O.C)
	886-2-2657-9980
	886-2-2657-3630
	sales_twn@gs-power.com

RD Division	
	824 Bolton Drive Milpitas. CA. 95035
	1-408-457-0587