

GS321

Low Power Single Operational Amplifiers

Product Description

The GS321 brings performance and economy to low power systems.

With a high unity gain frequency and a guaranteed $0.4\text{V}/\mu\text{s}$ slew rate, the quiescent current is only $430\mu\text{A}/\text{amplifier}$ (5V).

The input common mode range includes ground and therefore the device is able to operate in single supply applications as well as in dual supply applications. It is also capable of comfortably driving large capacitive loads.

The GS321 is available in the SOT-23-5L package. Overall the GS321 is a low power, wide supply range performance op amp that can be designed into a wide range of applications at an economical price without sacrificing valuable board space.

Features

- Low supply current: $430\mu\text{A}$
- Low input bias current: 20nA
- Wide supply voltage range: $+3\text{V}$ to $+32\text{V}$
- Single version of GS358
- RoHS Compliant and Halogen Free

Applications

- Chargers
- Power supplies
- Industrial: controls, instruments
- Desktops
- Communications infrastructure

Block Diagram

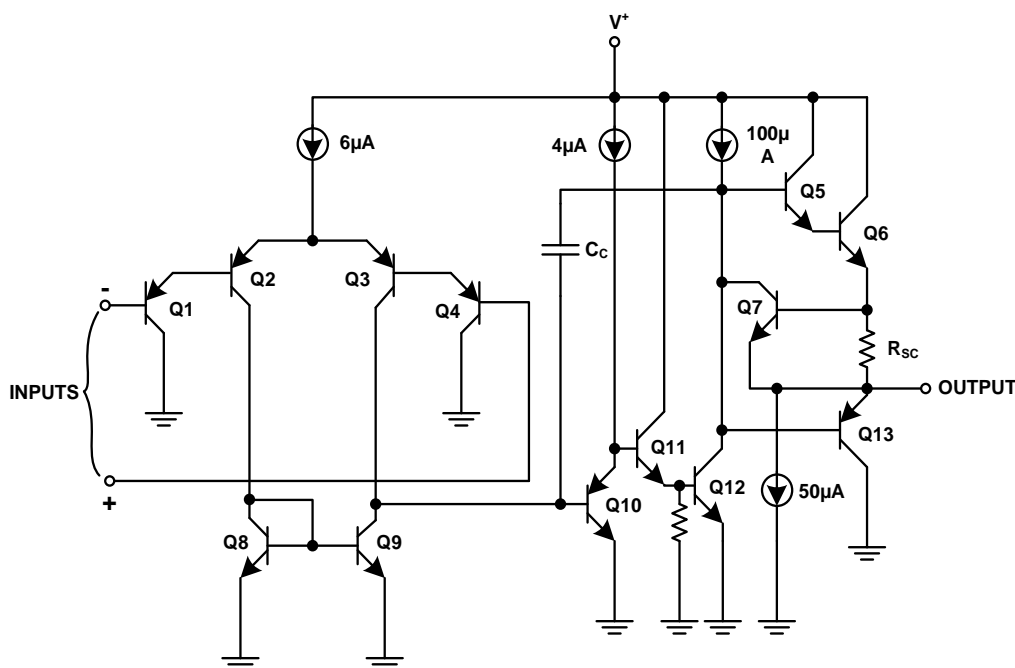

Pin Assignments

GS321LF Top View		GS321ALF Top View	
Pin No	Pin Name	Pin No	Pin Name
1	V _{IN+}	1	V _{OUT}
2	GND	2	GND
3	V _{IN-}	3	V _{IN+}
4	V _{OUT}	4	V _{IN-}
5	V _{CC+}	5	V _{CC+}

Ordering Information

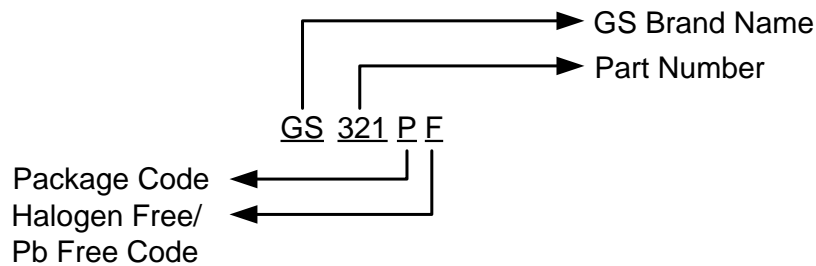

Device	Package	Quantity Reel
GS321LF	SOT-23-5L	3000 PCS
GS321ALF	SOT-23-5L	3000 PCS

Marking Information

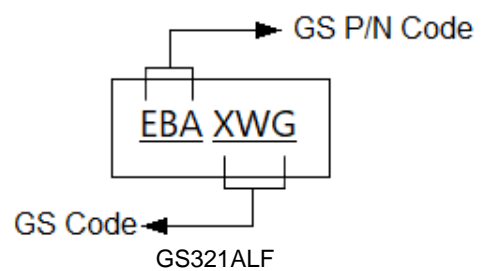
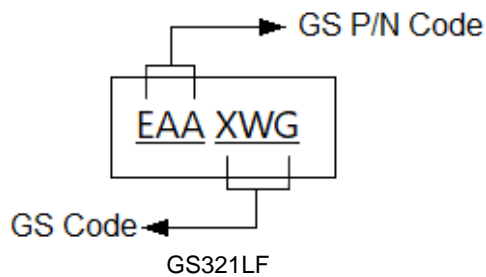

Absolute Maximum Ratings (Note 1)

Symbol	Parameter	Value	Unit
V _{CC}	Supply Voltage, (V ⁺ - V ⁻)	32	V
+IN	Input Voltage	-0.3 ~ +32	V
Output	Output Short Circuit to GND V ⁺ ≤ 15V and T _A = 25°C (Note 2)	Continuous	
T _J	Junction Temperature (Note 3)	150	°C
θ _{JA}	Thermal Resistance to Ambient (θ _{JA})	265	°C
T _A	Operating Temperature Range	-40 ~ +85	°C
T _{STG}	Storage Temperature Range	-65 ~ +150	°C

Electrical Characteristics

Unless otherwise specified: V⁺ = 5.0V

Symbol	Parameter	Test Conditions	Min	Typ	Max	Unit
V _{IO}	Input offset voltage	T _A = 25°C (Note 4)		2	5	mV
I _B	Input Bias Current	T _A = 25°C, I _{IN(+)} or I _{IN(-)} , V _{CM} = 0V (Note 5)		20	150	nA
I _{OS}	Input offset Current	T _A = 25°C, I _{IN(+)} - I _{IN(-)} , V _{CM} = 0V		3	30	nA
V _{ICR}	Input Common-Mode Voltage Range	T _A = 25°C, V ⁺ = 30V (Note 6)	0		V ⁺ - 1.5	V
I _{CC}	Supply Current	Over Full Temperature Range, R _L = ∞ on all Op Amps	V ⁺ = 30V	0.7	2	mA
		V ⁺ = 5V	0.5	1.2		
A _{VD}	Large Signal Voltage Gain	V ⁺ = 15V, T _A = 25°C, R _L ≥ 2kΩ (For V _O = 1 ~ 11V)	50	100		V/mV
CMRR	Common Mode Rejection Ratio	DC, T _A = 25°C, V _{CM} = 0 ~ V ⁺ - 1.5V	70	90		dB
PSRR	Power Supply Rejection Ratio	DC, T _A = 25°C, V ⁺ = 5 ~ 30V	75	100		dB
I _{SOURCE}	Output Current Sourcing	V _{IN(+)} = 1V, V _{IN(-)} = 0V, V ⁺ = 15V, V _O = 2V, T _A = 25°C	20	40		mA
I _{SINK}	Output Current Sinking	V _{IN(-)} = 1V, V _{IN(+)} = 0V, V ⁺ = 15V, V _O = 2V, T _A = 25°C	10	20		mA
		V _{IN(-)} = 1V, V _{IN(+)} = 0V, V ⁺ = 15V, V _O = 200mV, T _A = 25°C	12	50		μA
I _{SHORT}	Short Circuit to Ground	V ⁺ = 15V, T _A = 25°C (Note 2)		40	85	μA
V _{OH}	Output Voltage Swing	V ⁺ = 30V	R _L = 2kΩ	26		V
			R _L = 10kΩ	27	28	V
V _{OL}		V ⁺ = 5V, R _L = 10kΩ		5	20	mV
Amplifier-to-Amplifier Coupling		T _A = 25°C, f = 1 ~ 20kHz (Input Referred) (Note 7)		-120		dB

- Note 1:** Absolute Maximum Ratings indicate limits beyond which damage to the device may occur. Operating Ratings indicate conditions for which the device is intended to be functional, but specific performance is not guaranteed. For guaranteed specifications and the test conditions, see the Electrical Characteristics.
- Note 2:** Short circuits from the output to V^+ can cause excessive heating and eventual destruction. When considering short circuits to ground, the maximum output current is approximately 40mA independent of the magnitude of V^+ . At values of supply voltage in excess of +15V, continuous short-circuits can exceed the power dissipation ratings and cause eventual destruction. Destructive dissipation can result from simultaneous shorts on all amplifiers.
- Note 3:** The maximum power dissipation is a function of $T_{J(MAX)}$, θ_{JA} , and T_A . The maximum allowable power dissipation at any ambient temperature is $P_D = (T_{J(MAX)} - T_a) / \theta_{JA}$. All numbers apply for packages soldered directly onto a PC board.
- Note 4:** $V_o=1.4V$, $R_s = 0\Omega$ with V^+ from 5V to 30V; and over the full input common-mode range (0V to $V^+ - 1.5V$) at 25°C.
- Note 5:** The direction of the input current is out of the IC due to the PNP input stage. This current is essentially constant, independent of the state of the output so no loading change exists on the input lines.
- Note 6:** The input common-mode voltage of either input signal voltage should not be allowed to go negative by more than 0.3V (at 25°C). The upper end of them common-mode voltage range is $V^+ - 1.5V$ (at 25°C), but either or both inputs can go to +32V without damage, independent of the magnitude of V^+ .
- Note 7:** Due to proximity of external components, insure that coupling is not originating via stray capacitance between these external parts. This typically can be detected as this type of capacitance increases at higher frequencies.

Application Circuit

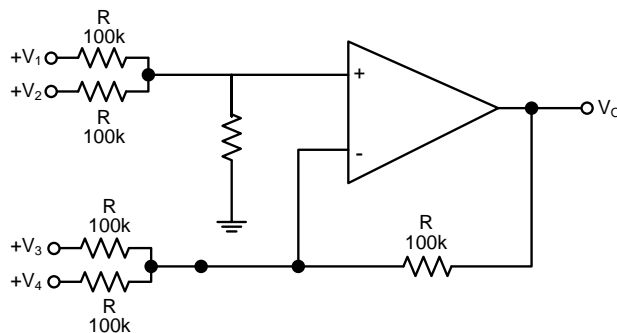

DC Summing Amplifier
($V_{IN}'S \geq 0 V_{DC}$ and $V_o \geq V_{DC}$)

Where: $V_o = V_1 + V_2 - V_3 - V_4$, $(V_1 + V_2) \geq (V_3 + V_4)$ to keep $V_o > 0 V_{DC}$

Non-Inverting DC Gain (0V Input = 0V Output)

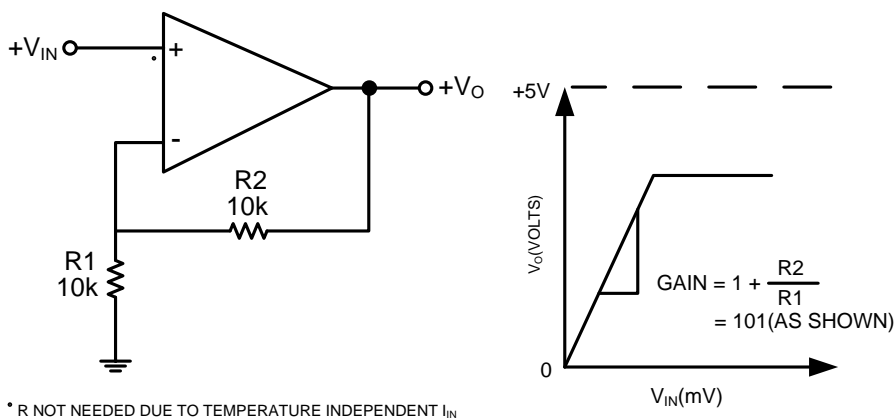

Application Summary

The GS321 op amp can operate with a single or dual power supply voltage, has true-differential inputs, and remain in the linear mode with an input common-mode voltage of 0 V_{DC} . This amplifier operates over a wide range of power supply voltages, with little change in performance characteristics. At 25°C amplifier operation is possible down to a minimum supply voltage of 3V.

Large differential input voltages can be easily accommodated and, as input differential voltage protection diodes are not needed, no large input currents result from large differential input voltages. The differential input voltage may be larger than V^+ without damaging the device. Protection should be provided to prevent the input voltages from going negative more than $-0.3 V_{DC}$ (at 25°C). An input clamp diode with a resistor to the IC input terminal can be used.

To reduce the power supply drain, the amplifier has a class A output stage for small signal levels which converts to class B in a large signal mode. This allows the amplifiers to both source and sink large output currents. Therefore both NPN and PNP external current boost transistors can be used to extend the power capability of the basic amplifiers. The output voltage needs to raise approximately 1 diode drop above ground to bias the on-chip vertical PNP transistor for output current sinking applications.

For AC applications, where the load is capacitively coupled to the output of the amplifier, a resistor should be used, from the output of the amplifier to ground to increase the class A bias current and to reduce distortion.

Capacitive loads which are applied directly to the output of the amplifier reduce the loop stability margin. Values of 50pF can be accommodated using the worst-case non-inverting unity gain connection. Large closed loop gains or resistive isolation should be used if large load capacitance must be driven by the amplifier.

The bias network of the GS321 establishes a supply current which is independent of the magnitude of the power supply voltage over the range of from 3 V_{DC} to 30 V_{DC} .

Output short circuits either to ground or to the positive power supply should be of short time duration. Units can be destroyed, not as a result of the short circuit current causing metal fusing, but rather due to the large increase in IC chip dissipation which will cause eventual failure due to excessive junction temperatures. The larger value of output source current which is available at 25°C provides a larger output current capability at elevated temperatures than a standard IC op amp.

The circuits presented in the section on typical applications emphasize operation on only a single power supply voltage. If complementary power supplies are available, all of the standard op amp circuits can be used. In general, introducing a pseudo-ground (a bias voltage reference of $V^+/2$) will allow operation above and below this value in single power supply systems. Many application circuits are shown which take advantage of the wide input common-mode voltage range which includes ground. In most cases, input biasing is not required and input voltages which range to ground can easily be accommodated.

Typical Performance Characteristics

Small Signal Pulse Response

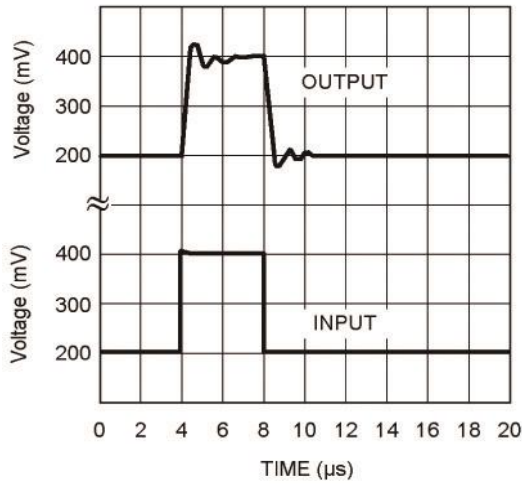

Large Signal Pulse Response

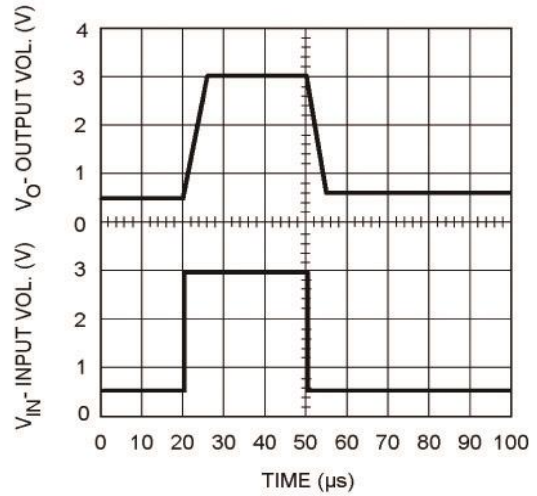

Supply Current vs. Supply Voltage

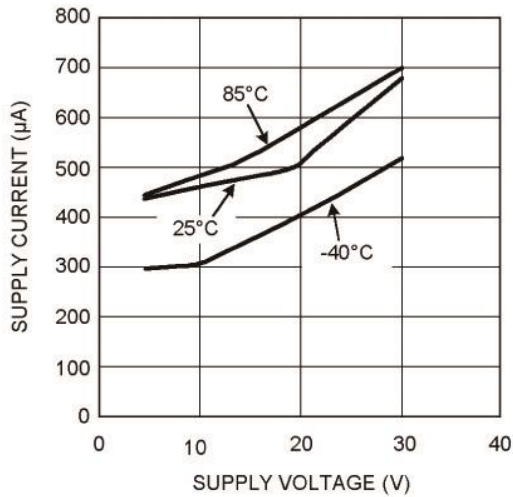

Sinking Current vs. Output Voltage

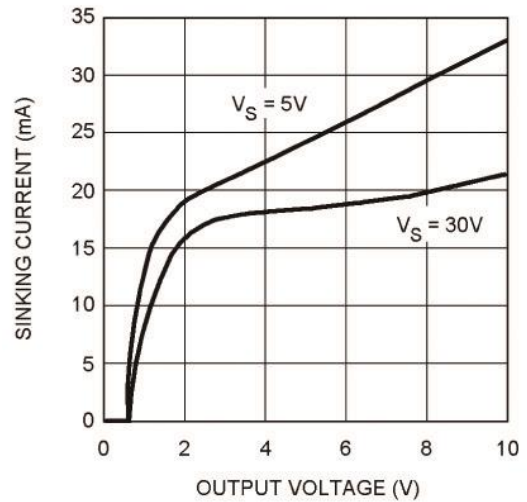

Source Current vs. Output Voltage

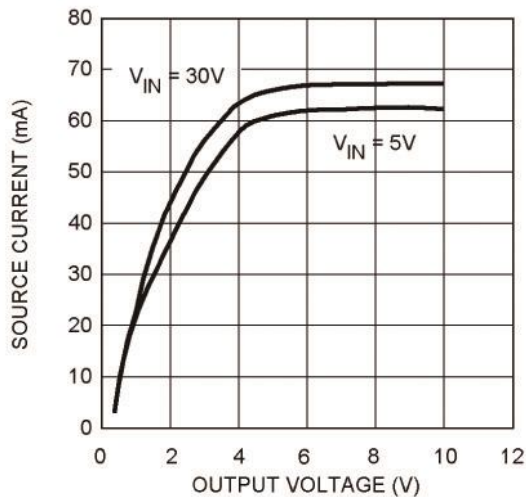

Open Loop Frequency Response

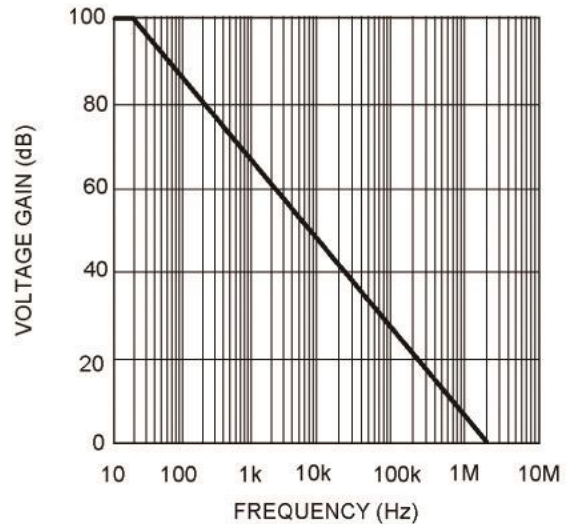

Package Dimension

SOT-23-5L

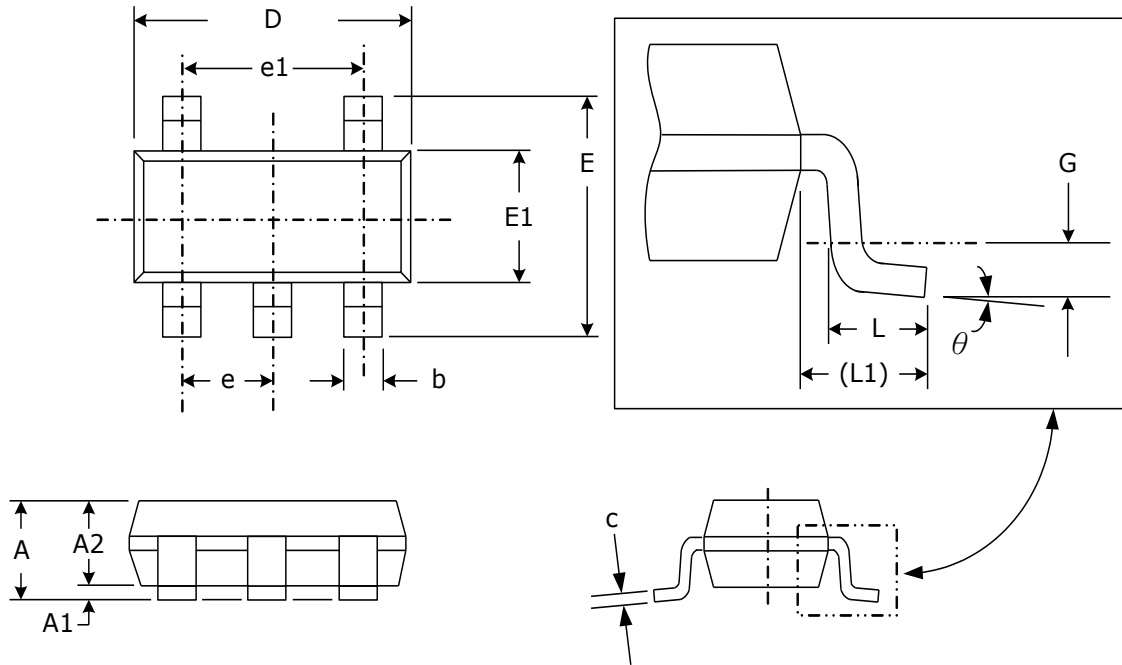





Dimensions



SYMBOL	Millimeters		Inches	
	MIN	MAX	MIN	MAX
A	0.95	1.45	.037	.057
A1	0.05	0.15	.002	.006
A2	0.90	1.30	.035	.051
b	0.30	0.50	.012	.020
c	0.08	0.20	.003	.008
D	2.80	3.00	.110	.118
E	2.60	3.00	.102	.118
E1	1.50	1.70	.059	.067
e	0.95 (TYP)		.037 (TYP)	
e1	1.90 (TYP)		.075 (TYP)	
L	0.35	0.55	.014	.022
L1	0.60 (TYP)		.024 (TYP)	
G	0.25 (TYP)		.010 (TYP)	
θ	0°	8°	0°	8°

NOTICE

Information furnished is believed to be accurate and reliable. However Globaltech Semiconductor assumes no responsibility for the consequences of use of such information nor for any infringement of patents or other rights of third parties, which may result from its use. No license is granted by implication or otherwise under any patent or patent rights of Globaltech Semiconductor. Specifications mentioned in this publication are subject to change without notice. This publication supersedes and replaces all information without express written approval of Globaltech Semiconductor.

CONTACT US

GS Headquarter	
	4F.,No.43-1,Lane11,Sec.6,Minquan E.Rd Neihu District Taipei City 114, Taiwan (R.O.C)
	886-2-2657-9980
	886-2-2657-3630
	sales_twn@gs-power.com

RD Division	
	824 Bolton Drive Milpitas. CA. 95035
	1-408-457-0587