

GSM49B4S

40V N-Channel MOSFETs

Product Description

These N-Channel enhancement mode power field effect transistors are using trench DMOS technology. This advanced technology has been especially tailored to minimize on-state resistance, provide superior switching performance, and withstand high energy pulse in the avalanche and commutation mode.

These devices are well suited for high efficiency fast switching applications.

Features

- 40V, 7.9A, $R_{DS(ON)}=13.5m\Omega@V_{GS}=10V$
- Improved dv/dt capability
- Fast switching
- Green Device Available

Applications

- Notebook
- Load Switch
- LED applications
- Hand-Held Device

Packages & Pin Assignments

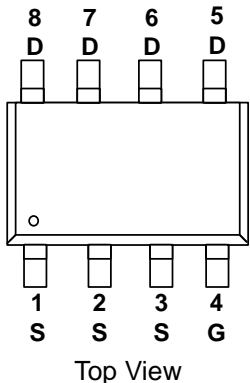
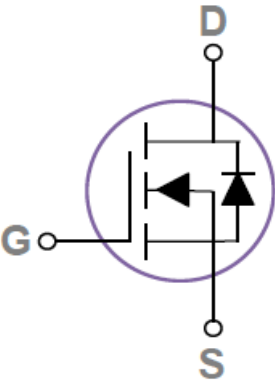
GSM49B4SF (SOP-8)		
 <p>Top View</p>		
		
Pin No	Symbol	Description
1,2,3	S	Source
4	G	Gate
5,6,7,8	D	Drain

Ordering Information

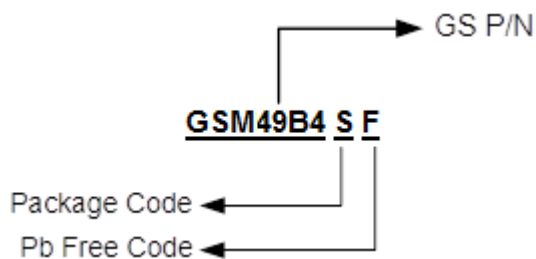

Part Number	Package	Quantity Reel
GSM49B4SF	SOP-8	4000 PCS

Marking Information

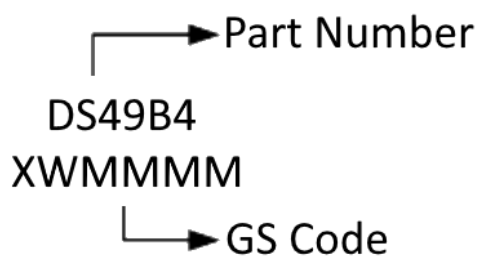

Absolute Maximum Ratings

T_c=25°C Unless otherwise noted

Symbol	Parameter	Typical	Unit
V _{DS}	Drain-Source Voltage	40	V
V _{GS}	Gate-Source Voltage	+20/-12	V
I _D	Continuous Drain Current	T _c =25°C	7.9
		T _c =70°C	6.3
I _{DM}	Pulsed Drain Current ¹	31.6	A
EAS	Single Pulse Avalanche Energy ²	24.2	mJ
IAS	Single Pulse Avalanche Current ²	22	A
P _D	Power Dissipation (T _c =25°C)	1.47	W
	Power Dissipation (Derate above 25°C)	0.12	W/°C
T _{STG}	Storage Temperature Range	-55 to +150	°C
T _J	Operating Junction Temperature Range	-55 to +150	°C
R _{θJA}	Thermal Resistance-Junction to Ambient	85	°C/W

Electrical Characteristics

T_J=25°C Unless otherwise noted

Symbol	Parameter	Conditions	Min	Typ	Max	Unit
Static						
V _{(BR)DSS}	Drain-Source Breakdown Voltage	V _{GS} =0V, I _D =250uA	40	---	---	V
ΔBV _{DSS} /ΔT _J	BV _{DSS} Temperature Coefficient	Reference to 25°C, I _D =1mA	---	0.02	---	V/°C
V _{GS(th)}	Gate Threshold Voltage	V _{DS} =V _{GS} , I _D =250uA	1.0	1.5	2.5	V
ΔV _{GS(th)}	V _{GS(th)} Temperature Coefficient		---	4.0	---	mV/°C
I _{GSS}	Gate-Source Leakage Current	V _{DS} =0V, V _{GS} =+20V	---	---	100	nA
I _{DSS}	Drain-Source Leakage Current	V _{DS} =40V, V _{GS} =0V T _J =25°C	---	---	1	uA
		V _{DS} =32V, V _{GS} =0V, T _J =85°C	---	---	10	
I _S	Continuous Source Current	V _G =V _D =0V, Force Current	---	---	7.9	A
I _{SM}	Pulsed Source Current		---	---	15.8	
R _{DS(on)}	Drain-Source On-Resistance	V _{GS} =10V, I _D =4A	---	11	13.5	mΩ
		V _{GS} =10V, I _D =4A, T _J =125°C	---	16.3	---	
		V _{GS} =4.5V, I _D =3A	---	17.5	22	

Electrical Characteristics (Continue)

Symbol	Parameter	Conditions	Min	Typ	Max	Unit
Static						
g _{FS}	Forward Transconductance	V _{DS} =10V, I _D =1A	---	4	---	S
V _{SD}	Diode Forward Voltage	V _{GS} =0V, I _S =1A T _J =25°C	---	---	1	V
Dynamic						
Q _g	Total Gate Charge ^{3,4}	V _{DS} =32V, V _{GS} =4.5V, I _D =4A	---	6.9	14	nC
Q _{gs}	Gate-Source Charge ^{3,4}		---	0.6	1.2	
Q _{gd}	Gate-Drain Charge ^{3,4}		---	3.2	6.4	
C _{iss}	Input Capacitance	V _{DS} =25V, V _{GS} =0V, f=1MHz	---	451	900	pF
C _{oss}	Output Capacitance		---	210	420	
C _{rss}	Reverse Transfer Capacitance		---	27	54	
t _{d(on)}	Turn-On Time ^{3,4}	V _{DD} =20V, I _D =1A, V _{GS} =10V, R _G =1Ω	---	3.9	7.8	ns
t _r			---	18.1	38	
t _{d(off)}	Turn-Off Time ^{3,4}		---	16.2	32	
t _f			---	57.5	116	
R _g	Gate Resistance	V _{DS} =0V, V _{GS} =0V, f=1MHz	---	1.9	---	Ω

Note :

1. Repetitive Rating : Pulsed width limited by maximum junction temperature.
2. V_{DD}=25V, V_{GS}=10V, L=0.1mH, I_{AS}=22A, R_G=25Ω, Starting T_J=25°C.
3. The data tested by pulsed , pulse width ≤ 300us , duty cycle ≤ 2%.
4. Essentially independent of operating temperature.

Typical Performance Characteristics

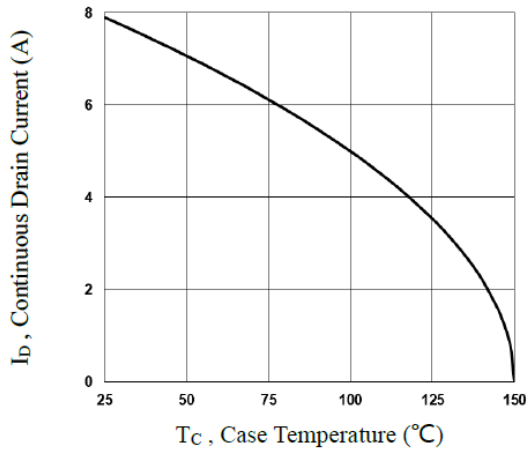

Fig.1 Continuous Drain Current vs. T_c

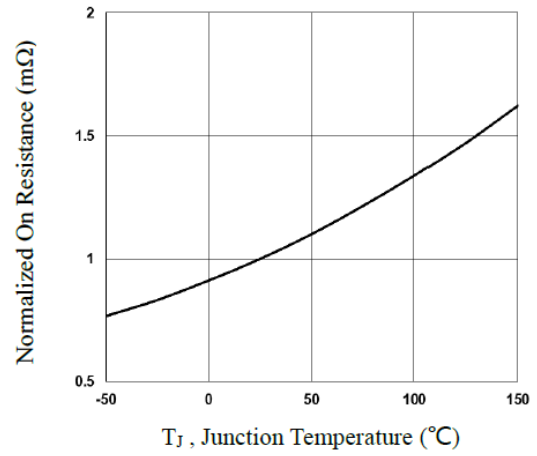

Fig.2 Normalized R_{DS(on)} vs. T_J

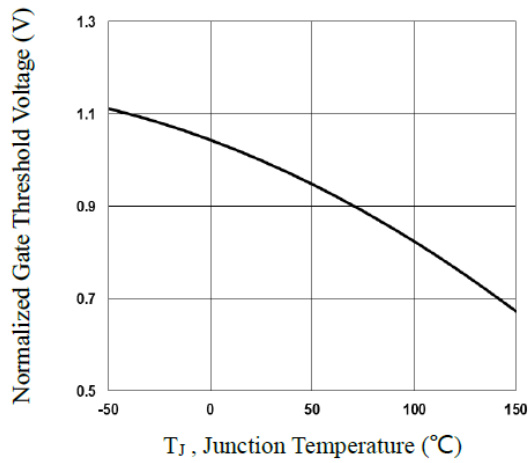

Fig.3 Normalized V_{th} vs. T_J

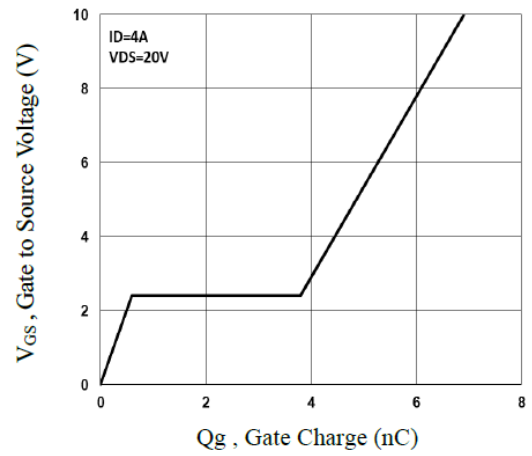

Fig.4 Gate Charge Waveform

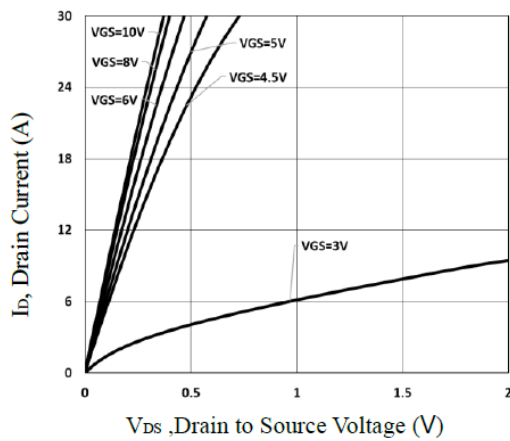

Fig.5 Typical Output Characteristics

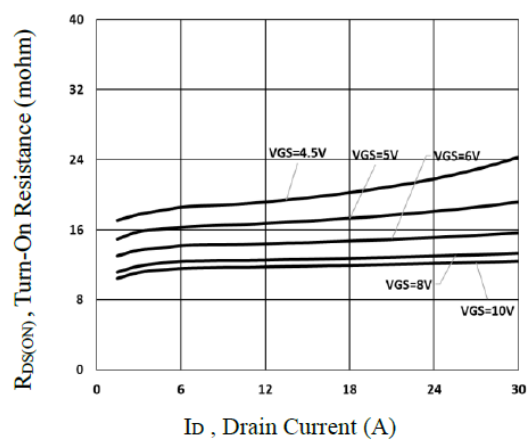

Fig.6 Turn-On Resistance vs. I_D

Typical Performance Characteristics (Continue)

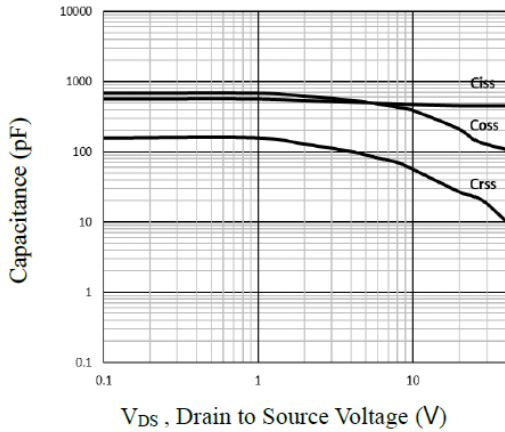

Fig.7 Capacitance Characteristics

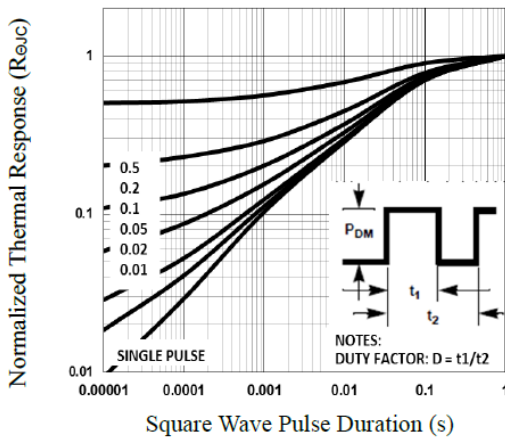

Fig.8 Normalized Transient Response

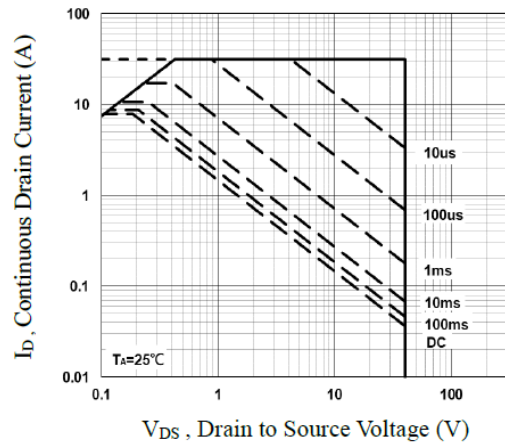

Fig.9 Maximum Safe Operation Area

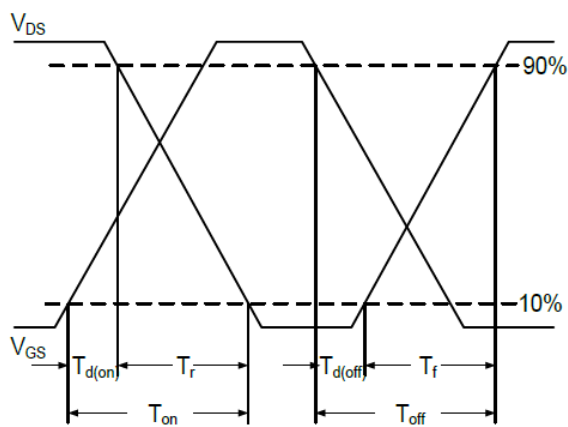

Fig.10 Switching Time Waveform

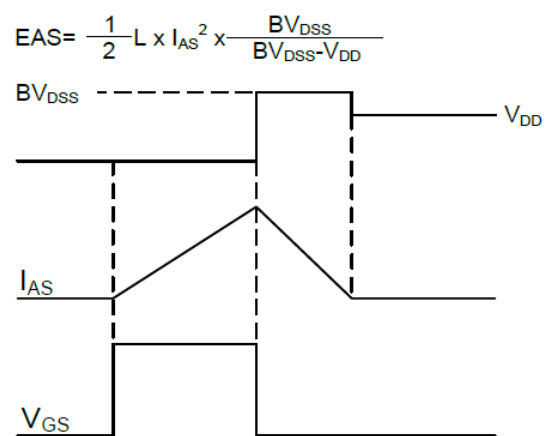
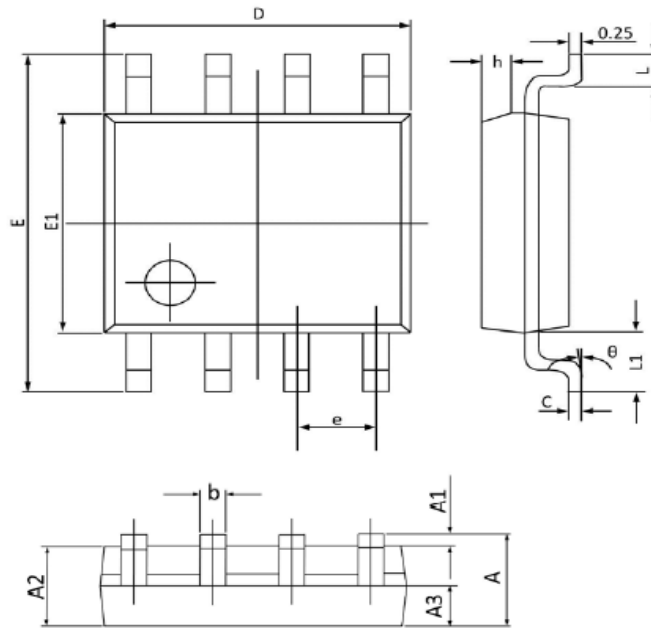

Fig.11 EAS Waveform

Package Dimension

SOP-8







Dimensions



Symbol	Millimeters		Inches	
	Min	Max	Min	Max
A	1.350	1.750	0.053	0.068
A1	0.100	0.250	0.004	0.009
A2	1.300	1.500	0.052	0.059
A3	0.600	0.700	0.024	0.027
b	0.390	0.480	0.016	0.018
c	0.210	0.260	0.009	0.010
D	4.700	5.100	0.186	0.200
E	5.800	6.200	0.229	0.244
E1	3.700	4.100	0.146	0.161
e	1.270 (BSC)		0.050 (BSC)	
h	0.250	0.500	0.010	0.019
L	0.500	0.800	0.019	0.031
L1	1.050 (BSC)		0.041 (BSC)	
theta	0°	8°	0°	8°

NOTICE

Information furnished is believed to be accurate and reliable. However Globaltech Semiconductor assumes no responsibility for the consequences of use of such information nor for any infringement of patents or other rights of third parties, which may result from its use. No license is granted by implication or otherwise under any patent or patent rights of Globaltech Semiconductor. Specifications mentioned in this publication are subject to change without notice. This publication supersedes and replaces all information without express written approval of Globaltech Semiconductor.

CONTACT US

GS Headquarter	
	4F.,No.43-1,Lane11,Sec.6,Minquan E.Rd Neihu District Taipei City 114, Taiwan (R.O.C)
	886-2-2657-9980
	886-2-2657-3630
	sales_twn@gs-power.com

RD Division	
	824 Bolton Drive Milpitas. CA. 95035
	1-408-457-0587