

GSD5004SJZF

Switching Diode

Product Description

Switching Diode 400V and 300mA

Features

- Fast Switching Speed.
- Low Reverse Leakage Current

Mechanical Data

- SOT-23 Package
- Epoxy Meets UL 94 V-0 Flammability Rating
- RoHS Compliant and Halogen Free

Package & Pin Assignment

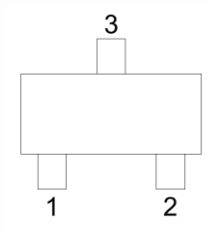
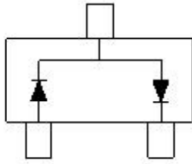
SOT-23			Equivalent Circuit		
					
Pin	Symbol	Description	Pin	Symbol	Description
1	A1	Anode 1	3	Common	Cathode 1 & Anode 2
2	K2	Cathode 2			

Ordering and Marking Information

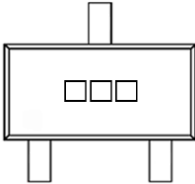
Ordering Information			
Part Number	Package	Marking Code	Quantity / Reel
GSD5004SJZF	SOT-23	KJB	3,000 PCS
GSD5004 1 2 F			
<ul style="list-style-type: none"> - Product Code: GSD5004 - Circuit Type Code: 1 is S - Package Code: 2 JZ for SOT-23 			
<ul style="list-style-type: none"> - Green Level: - F for RoHS Compliant and Halogen Free 			
Marking Information			
	<ul style="list-style-type: none"> - Product Code: is KJB 		

Absolute Maximum Ratings (T_A=25°C unless otherwise specified)

Symbol	Parameter	Value	Units	
V _{RRM}	Repetitive Peak Reverse Voltage	400	V	
V _{RM}	Non-Repetitive Peak Reverse Voltage	350	V	
V _{R(RMS)}	RMS Reverse Voltage	247	V	
I _F	Forward Continuous Current	300	mA	
I _{FRM}	Repetitive Peak Forward Current	625	mA	
I _{FSM}	Non-Repetitive Peak Forward Surge Current	t=1.0μs	5	A
		t=1.0ms	3	A
P _D	Power Dissipation	350	mW	
R _{θJA}	Thermal Resistance from Junction to Ambient	357	°C/W	
T _J	Junction Temperature	150	°C	
T _{STG}	Storage Temperature	-55 to +150	°C	

These ratings are limiting Values above which the serviceability of the diode may be impaired.

Electrical Characteristics (T_A=25°C unless otherwise specified)

Symbol	Parameter	Test Condition	Min	Max	Units
V _F	Forward Voltage	I _F =20mA		0.93	V
		I _F =100mA		1.10	V
		I _F =200mA		1.29	V
V _R	Reverse Breakdown Voltage	I _R =150μA	400		V
I _R	Reverse Current	V _R = 240V		150	nA
		V _R = 360V		5.0	μA
C _T	Capacitance	V _R = 0V, f = 1MHz		2	pF
t _{rr}	Reverse Recovery Time	I _F = I _R =30mA, I _{RR} = 0.1x I _R R _L = 100Ω		50	ns

SOT-23

Package Dimension

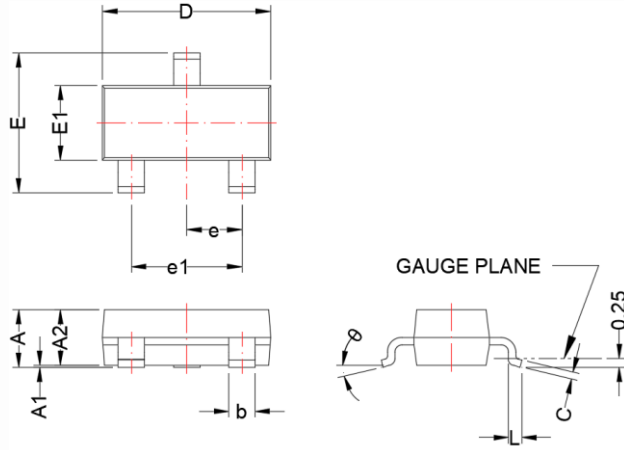

Recommended Land Pattern

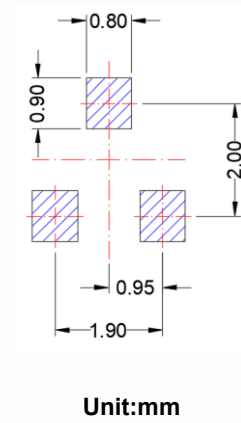

Unit:mm

Dimensions				
Symbol	Millimeters		Inches	
	MIN	MAX	MIN	MAX
A	0.75	1.17	0.030	0.046
A1	0.01	0.15	0.000	0.006
A2	0.70	1.02	0.028	0.040
b	0.30	0.50	0.012	0.020
c	0.08	0.20	0.003	0.008
D	2.80	3.04	0.110	0.120
E	2.10	2.64	0.083	0.104
E1	1.20	1.40	0.047	0.055
e	0.95 BSC		0.037 BSC	
e1	1.90 BSC		0.075 BSC	
L	0.30	0.60	0.012	0.024
θ	0°	8°	0°	8°





NOTE:



Dimensions are exclusive of Burrs, Mold Flash & Tie Bar extrusions.

NOTICE

- Globaltech Semiconductor assumes no responsibility for equipment failures that result from using products at values that exceed, even momentarily, rated values (such as maximum ratings, operating condition ranges, or other parameters) listed in products specifications of any and all Globaltech Semiconductor products described or contained herein. Globaltech Semiconductor products are not designed for use in life support appliances, devices or systems where malfunction of these products can be reasonably expected to result in personal injury. Reproduction in whole or in part is prohibited without the prior written consent of the copyright owner.
- Applications shown on the herein document are examples of standard use and operation. Customers are responsible in comprehending the suitable use in particular applications. Globaltech Semiconductor makes no representation or warranty that such applications will be suitable for the specified use without further testing or modification.
- The information furnished is believed to be accurate and reliable. However, Globaltech Semiconductor assumes no responsibility for the consequences of use of such information nor for any infringement of patents or other rights of third parties, which may result from its use. No license is granted by implication or otherwise under any patent or patent rights of Globaltech Semiconductor. Specifications mentioned in this publication are subject to change without notice. This publication supersedes and replaces all information without express written approval of Globaltech Semiconductor.

CONTACT US

GS Headquarter	
	4F, NO.43-1, Lane 11, Sec. 6, Minquan E. Rd Neihu District, Taipei City 114761, Taiwan (R.O.C).
	886-2-2657-9980
	886-2-2657-3630
	sales_twn@gs-power.com

RD Division	
	824 Bolton Drive Milpitas. CA. 95035
	1-408-457-0587